

CN51

Mobile Computer with Android™



User Manual

Intermec by Honeywell
16201 25th Ave.W.
Lynnwood, WA 98087
U.S.A.

The information contained herein is provided solely for the purpose of allowing customers to operate and service Intermec-manufactured equipment and is not to be released, reproduced, or used for any other purpose without written permission of Intermec by Honeywell.

Information and specifications contained in this document are subject to change without prior notice and do not represent a commitment on the part of Intermec by Honeywell.

© 2015–2016 Honeywell International Inc. All rights reserved.

For patent information, please refer to www.hsmpats.com.

Android, Google, and other marks are trademarks of Google Inc.

Bluetooth is a trademark of Bluetooth SIG, Inc., U.S.A.

Wi-Fi is a registered certification mark of the Wi-Fi Alliance.

This product includes software developed by the OpenSSL Project for use in the OpenSSL Toolkit (www.openssl.org).

Document Change Record

This page records changes to this document. The document was originally released as Revision 001.

Version Number	Date	Description of Change
003	7/2016	Revised to support Android 6.0.
002	3/2014	Revised to support Android 4.2.2.

Contents

Customer Support	xi
Product Service and Repair	xi
Limited Warranty	xi
Send Feedback	xi
Hearing Aid Compatibility (HAC)	xii
Device Listings	xii

1 About the Computer Features 1

About the CN51 Mobile Computer	2
About the Battery	4
Charge the Battery	4
Change the Battery	5
About Battery Status	6
Check the Battery Level	8
Change the Battery Status LED Behavior	8
About Battery Life and Conservation	9
Enable Airplane Mode	10
About the Status LEDs	10
About the Keypad	12
About the Color-Coded Keys	13
How to Capitalize Characters on the QWERTY Keypad	13
How to Capitalize Characters on the Numeric Keypad	14
About the Power Button	14
About the Screen Backlight	15
Configure the Screen Backlight Brightness	15
About the Audio Features	15
Adjust the Ringtone and Notification Volume	15
Enable Vibrate Mode	17
Audio Settings	18
Insert a MicroSD Card	19
How to Transfer Files	21
Configure the USB Connection for Transferring Files	21
CN51 Accessories	22

2 About the User Interface and Honeywell Applications 25

- About the User Interface 26
 - About the Home Screen 26
 - View Notifications 27
 - Customize the Home Screen 27
 - Customize the Favorites Tray 28
 - Use Google™ Search 28
 - About Screen Gestures 29
 - Set the Time Zone 29
 - Manage Notifications 30
- About Honeywell Applications 30
- Unlock Developer Options 31

3 Use the Scanner 33

- About the Scanner 34
- How to Scan Bar Codes as Keyboard Input 34
- Change the Scanner Settings 34
- Restore Default Scanner Settings 35
- Scan Bar Codes 35
- Use the Scan Demo App 37

4 Use the Phone 39

- About the Phone 40
 - Activate the UMTS Phone 40
 - Activate the CDMA Phone 43
- Make a Phone Call 43
- Answer the Phone 44
 - Send a Call to Voicemail 44
- Switch Apps During a Phone Call 44

Check Your Voicemail	45
Set Your Voicemail Number.	45
Change Voicemail Settings.	45
Make an Emergency Phone Call	46
Switch Between Network Carriers	46
Configure Phone Settings.	47
5 Use the Camera	49
About the Color Camera.	50
Take a Picture	50
Change Camera Settings.	50
Record a Video.	51
Change Video Settings	52
6 Configure the Computer	53
How to Configure the Computer	54
Start the Settings App	54
About the Structure of the Settings App	54
About Network Communications	57
Connect to a Wi-Fi Network	57
Configure Proxy Settings for a Wi-Fi Network	59
Disable Wi-Fi Notifications	60
Connect to an Ethernet Network	60
How to Connect to Virtual Private Networks	61
Add a VPN	61
Connect to a VPN	61
Edit VPN Information.	62
About Wireless Security	62
Configure Wireless Security.	62
About Certificates	63
Load a Certificate	63
Disable or Remove Certificates	64
About Bluetooth Communications	64
Connect a Bluetooth Device	65

Contents

Configure Bluetooth Settings	66
Rename or Disconnect a Paired Device	66
View a List of Received Files	67
About Serial and USB Communications	67
How to Share Your Mobile Data Connection	67
Share the Data Connection Through USB	68
Share the Data Connection Through Bluetooth	68
Share the Data Connection as a Portable Hotspot	68
7 Manage and Maintain the Computer	71
How to Transfer Files	72
Configure the USB Connection for Transferring Files	72
Connect to a PC through USB	73
How to Develop and Install Applications	73
Download and Install the SDK Components	74
How to Set Up the Mobile Computer for App Development	77
How to Update the System Software	78
Update Computers Using a Device Management System	78
Upgrade the System Software	78
Reset the Computer	79
Perform a Factory Data Reset	79
Clean the Computer	80
A Specifications	81
Physical and Environmental Specifications	82
EA31 Extended Reading Range	84
EA31 Minimum Reading Distances	85
EA31 Typical Reading Distances	86
EA30 Extended Reading Range	88
EA30 Minimum Reading Distances	89
EA30 Typical Reading Distances	90

B Default Settings	93
Wireless and Network Settings	94
Scanner Settings	94
Device Settings	97
Personal Settings	98
System Settings	99
Additional Honeywell Settings	101

Contents

Customer Support

If you need assistance installing or troubleshooting your product, contact us by using one of these methods:

Knowledge Base: www.hsmknowledgebase.com

Our Knowledge Base provides thousands of immediate solutions. If the Knowledge Base does not help you solve your problem, log into the Technical Support Portal to submit your problem or ask your question.

Technical Support Portal: www.hsmsupportportal.com

Log into the Technical Support Portal to search our Knowledge Base, submit your problem or question, request a call back, or provide feedback. When filling out one of the forms, provide as much detail as possible. You can even include attachments.

Telephone: www.honeywellaidc.com/locations

for our latest contact information, please check our website.

Product Service and Repair

Honeywell International Inc. provides service for all of its products through service centers throughout the world. To find your service center, go to www.honeywellaidc.com and select **Get Resources > Service and Repair**. Contact your service center to obtain a Return Material Authorization number (RMA #) before you return the product.

To obtain warranty or non-warranty service, return your product to Honeywell (postage paid) with a copy of the dated purchase record.

Limited Warranty

For warranty information, go to www.honeywellaidc.com and click **Get Resources > Product Warranty**.

Send Feedback

Your feedback is crucial to the continual improvement of our documentation. To provide feedback about this manual, please contact the Honeywell Technical Communications department directly at ACSHSMTechnicalCommunications@honeywell.com.

Hearing Aid Compatibility (HAC)

Device Listings

The standard for compatibility of digital wireless devices with hearing aids is set forth in American National Standards Institute (ANSI) standard C63.19. ANSI C63.19 contains these two sets of standards:

- An “M” rating from M1 to M4 for reduced radio frequency (RF) interference to enable acoustic coupling with hearing aids that do not operate in t-coil mode.
- A “T” rating from T1 to T4 to enable inductive coupling with hearing aids operating in t-coil mode.

A digital wireless handset is considered hearing aid compatible for acoustic coupling if it meets at least an “M3” rating under the ANSI standard. A digital wireless handset is considered hearing aid compatible for inductive coupling if it meets at least a “T3” rating under the ANSI standard.

M-Ratings: Devices rated M3 or M4 meet FCC requirements and are likely to generate less interference with hearing devices than devices that are not labeled. M4 is the superior/higher of the two ratings.

T-Ratings: Devices rated T3 or T4 meet FCC requirements and are likely to be more usable with a hearing device’s t-coil than unrated devices. T4 is the superior/higher of the two ratings.

These ratings are not guaranteed. Results will vary depending on the level of immunity of your hearing device and the degree of your hearing loss. If your hearing device happens to be vulnerable to interference, you may not be able to use a rated device successfully. Trying out the device with your hearing device is the best way to evaluate it for your personal needs.

When some wireless devices are used near some hearing devices such as hearing aids and implants, users may detect a buzzing or humming noise. Some hearing devices are more immune than others to this interference noise. Wireless devices may also vary in the amount of interference they generate. The more immune the hearing aid device is, the less likely one is to experience interference noise from the wireless device.

Hearing aid devices may also be rated. Adding the ratings of the hearing aid and the device can predict the usability of the two devices together:

- Any combined rating equal to or greater than six offers the best use.
- Any combined rating equal to five is considered normal use.

These models have been tested and rated for use with hearing aids for some of the wireless technologies that they use. However, there may be some newer wireless technologies used in these devices that have not been tested yet for use with hearing aids. It is important to try the different features of these devices thoroughly and in different locations, using your hearing aid or cochlear implant, to determine if you hear any interfering noise. Consult your service provider or the manufacturer of the device for information on hearing aid compatibility. If you have questions about return or exchange policies, consult your service provider or device retailer.

The following devices are currently offered:

Model Name	HAC Rating	Air-Interface	C63.19 Version
CN51	M3/T4	GSM/WCDMA	2011

1

About the Computer Features

This chapter introduces the CN51 Mobile Computer with Android™ 6.0 operating system. Use this chapter to learn about basic computer features and functions, as well as the available accessories for it.

About the CN51 Mobile Computer

The CN51 Mobile Computer is the class-leading mid-range rugged mobile computer, available with these features:

- Android 6.0 operating system
- 1.5 GHz dual-core multi-engine processor with extended battery life
- 1 GB DRAM, 16 GB flash memory
- Large, outdoor-viewable WVGA display with full-size keypad
- Resistive touch panel display
- Bluetooth radio
- UMTS/HSPA+/CDMA or UMTS/HSPA+ WAN radio options; both options support voice and data
- IEEE 802.11a/b/g/n on computers without a cellular radio, IEEE 802.11b/g/n on computers with a cellular radio
- Customer-accessible microSD slot for removable memory cards (up to 32 GB)
- High-performance EA30 or EA31 area imager options, for scanning bar codes and capturing signatures
- HTML5 support
- Integrated GPS receiver (with WAN radio option)
- Accelerometer that can automatically sense the angle of the computer and rotate the display between portrait and landscape
- 5-megapixel color camera

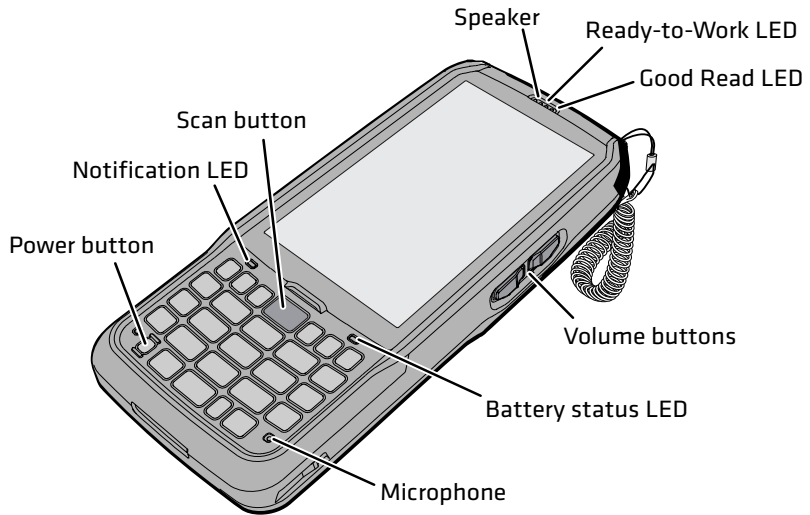

CN51 Front View

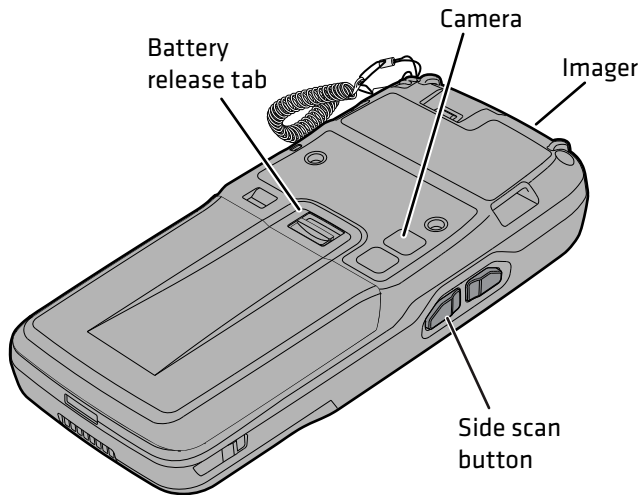

CN51 Back View

About the Battery

The CN51 uses a Model 1015AB01 battery as its main power source. The battery has a 14.4 Watt hour capacity. Several factors determine the life of your battery, such as display brightness, display timeout, input devices, extreme temperatures, and your usage.

Fully charge the battery before you use the CN51. When you change the battery, the computer automatically goes into a power-off state and then cold boots.



Caution: The battery used in this device may present a fire or chemical burn hazard if it is mistreated. Do not disassemble it, heat it above 100 °C (212 °F) or incinerate it. Dispose of used batteries promptly. Keep away from children.

Contact your Honeywell representative for replacement batteries.

Charge the Battery

Make sure you fully charge the battery (Model 1015AB01) before you use your CN51. You can charge the battery before or after you install it in the CN51. A fully discharged battery charges in approximately 6 hours.

- Insert the battery into a quad battery charger, a single dock, or a multidock, or attach external power to the CN51 with the battery installed.

The battery is fully charged when the battery status LED shows a steady green.

Use these Intermec accessories to charge the CN51 batteries:

- Quad Battery Charger (Model AC21)
- Charge-Only Multidock (Model AD23)
- Ethernet Multidock (Model AD24)
- Single Dock (Model AD27)
- Vehicle Power Adapter (Model AE36)
- AC Power Adapter (Model AE37)

Change the Battery

When the battery in the CN51 has a low charge, replace it with a charged battery to maintain your network connections.



Note: When you remove a battery from the computer, Honeywell recommends that you install a charged battery within 90 seconds to maintain your network connections.

- 1 Save all your files and close all open applications.
- 2 Press and hold the **Power** button. This menu appears:

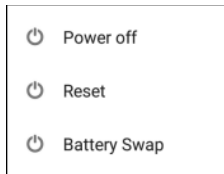

- 3 Tap **Battery Swap**. The computer briefly shows a status message and the LEDs turn on. When the LEDs turn off, continue with the next step.

If the computer is in a dock, you must remove it from the dock before you can select **Battery Swap**.

- 4 If necessary, disconnect the handstrap from the top of the computer.

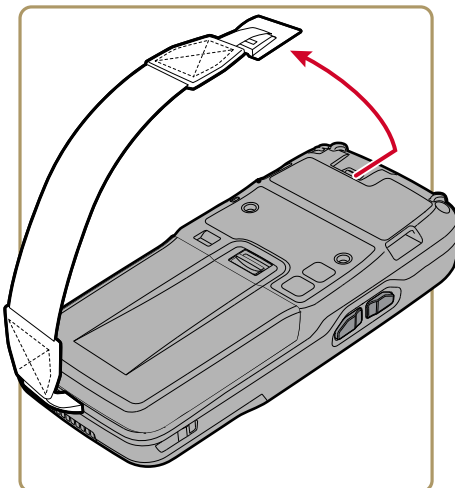

- 5 Push forward on the battery release tab until the battery releases, and then lift the battery away from the computer.

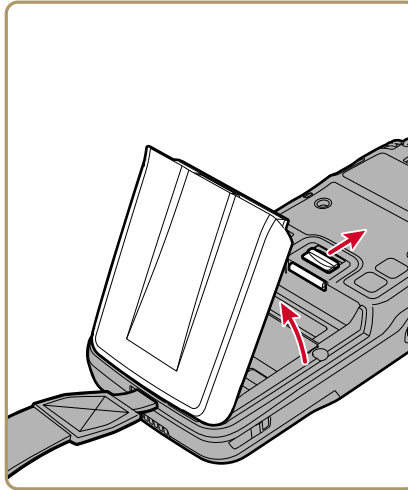





- 6 Insert the bottom end of a fully charged battery into the computer, and press down on the top end of the battery until it clicks into place.
- 7 If necessary, reattach the handstrap.

About Battery Status

Use the battery icon at the top of the screen to view the power status of the battery.

Battery Status Icons

Icon	Status
	Battery charge is at 100%.
	Battery charge is at 50%.
	Battery is critically low. You need to replace the battery now.
	Computer is connected to external power and the battery is charging.

Battery Status Icons (Continued)

Icon	Status
	There is a battery error. Install another battery. If the problem persists, call Honeywell Technical Support.

The Battery status LED below the computer screen indicates the charging status of the battery. You can also use the Battery status LED as a notification LED. For more information, see <http://developer.android.com/guide/topics/ui/notifiers/notifications.html>.

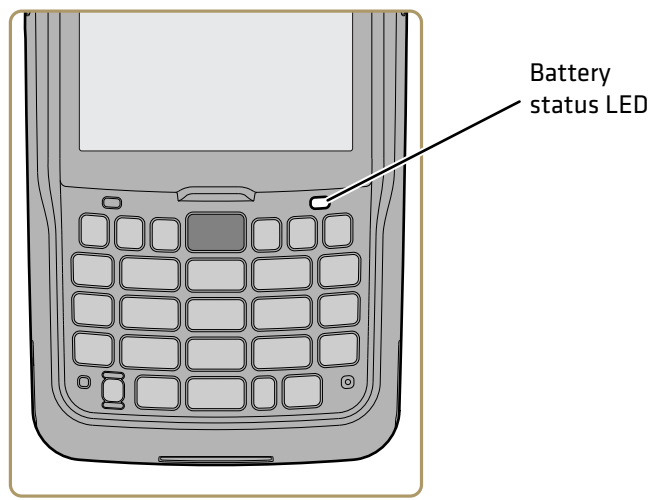

Out-of-Box Battery Status LED (HSM Battery LED) Descriptions

Connected to Power	LED State	Battery Level
No	Blinking amber	Below 20%
No	Off	More than 20%
Yes	Steady amber	Between 0% and 60%
Yes	Blinking green	Between 60% and 95%
Yes	Steady green	Above 95%
Either	Blinking red	Battery error

Check the Battery Level

Besides using the charge icons, you can get the battery level status from the Settings app.

- 1 Start the Settings app.
- 2 Tap **Battery** to see the current battery status and percentage level. A list shows the battery usage for individual apps and services.
For more details, tap an app or service in the list.



Note: If you turn off certain apps, the computer may not work correctly.

Change the Battery Status LED Behavior

You can change the behavior of the Battery status LED if the default behavior for a charging battery (blinking green) is not acceptable to your environment.

In addition to the out-of-box Battery status LED behavior, you can choose:

- Default Battery LED
- No Battery LED

Use the Default Battery LED setting if you want the status LED to turn on steady amber and then steady green when charging. Select the No Battery LED setting if you want to use the LED as a notification LED for applications or device management solutions.

Default Battery LED Descriptions

Connected to Power	LED State	Battery Level
No	Blinking red	Below 15%
No	Off	15% or more
Yes	Steady red	Below 15%
Yes	Steady amber	Between 15% and 90%
Yes	Steady green	90% or more

1 Tap **All Apps > Settings > Battery LED**.

2 Select one of these options:

- Default Battery LED
- HSM Battery LED (out-of-box setting)
- No Battery LED

About Battery Life and Conservation

Batteries that are stored outside the computer for long periods of time slowly discharge. Honeywell recommends storing the battery in a charger to maintain battery performance.

Battery Conservation Tips

When You Want To:	Do This to Save Battery Power:
Use the computer and the low battery status icon appears or the battery light turns on.	Connect the computer to an external power source. Press and hold the Power button, and then select Battery Swap from the menu. After the computer turns off, remove the battery and insert a fully charged battery.
Stop using the computer for 5 minutes or longer.	Make sure that the low battery status icon is not on the screen and the battery status LED is not on. Press the Power button to suspend the computer.
Store the computer for more than a day.	<ul style="list-style-type: none"> • If you are storing the computer for a few days, like over the weekend, install a charged battery or connect the computer to a power source. • If you are storing the computer for longer, remove and charge the battery, and then store both the battery and computer in a cool location. • If you store the battery for several months, recharge the battery to keep it at peak performance.
Store the battery outside the computer.	Store the battery in a charger.

Enable Airplane Mode

If you do not need to connect to any wireless networks, you can enable Airplane mode to turn off all the radios and save battery power.

There are two ways to enable Airplane mode:

- In the Settings app, tap **More** and select **Airplane mode** to enable the mode. If Airplane mode is already enabled, tap it to disable to mode.
- In the home screen, swipe down and tap , and then tap **Airplane mode** to enable the mode. If Airplane mode is already enabled, tap it to disable the mode.

About the Status LEDs

The status LEDs turn on, turn off, or blink to indicate a specific activity on your computer.

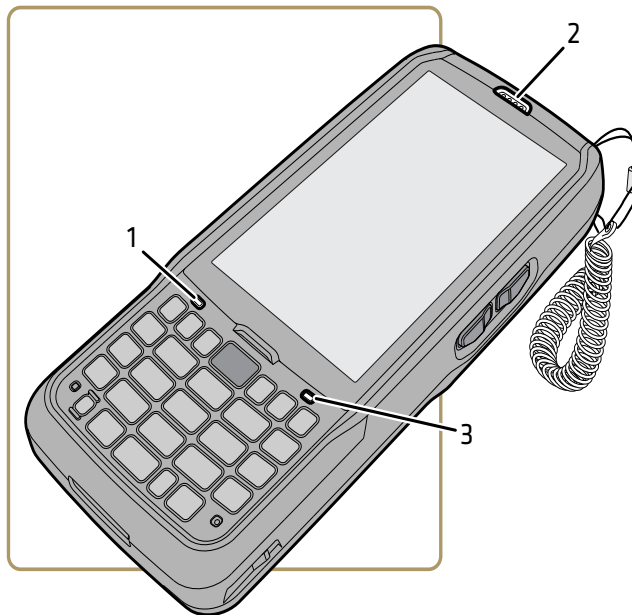

Main Status LED Descriptions

Callout	LED	Color	Description
1	Notification	Orange	Android OS notification.
2	Good Read	Green	Good read of a bar code.
		Blinking red	Bad read of a bar code.
3	Battery status	Blinking green	The data collection engine is processing or starting up.
		Varies	

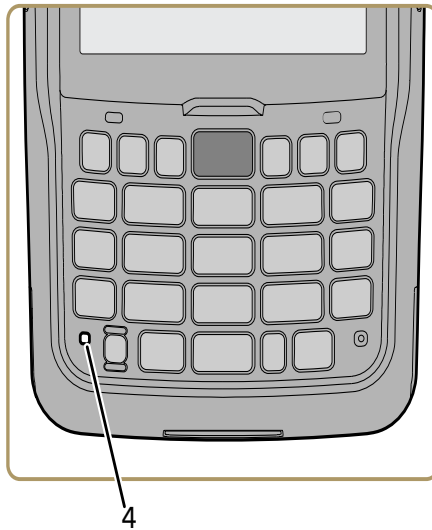

Orange and Green Key Status LED

Callout	LED	Color	Description
4	Orange and Green key status	Orange	The Orange key is enabled.
		Green	The Green key is enabled.

About the Keypad

The CN51 comes with either a numeric keypad or a QWERTY keypad:

- The numeric keypad is for applications that require mainly numeric data. This keypad also lets you enter special characters, including the alphabet, by pressing color-coded key sequences.
- The QWERTY keypad is designed for applications that require primarily alphabetic data. This keypad also lets you enter special characters by pressing color-coded key sequences.

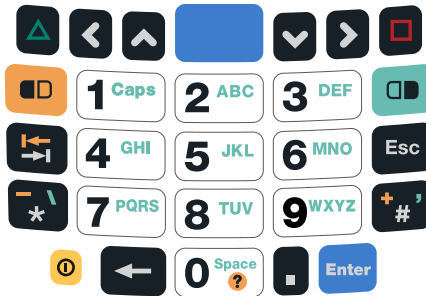

CN51 Numeric Keypad

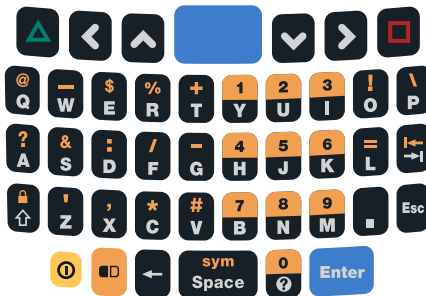



CN51 QWERTY Keypad

About the Color-Coded Keys











Note: The CN51 with QWERTY keypad does not have a green key.

Use the orange  key and the green  key to access additional characters, symbols, and functions printed on the keypad overlay. After you understand how to use the color-coded keys and key sequences, you can access all of the additional features printed on the keypad overlay.



Press the Green or Orange key twice to lock it. When the key is locked, the LED turns on. Press the key once to unlock it.

How to Use the Color-Coded Keys

You Want To	Press	Example
Use an orange character or function printed above a key.	 (LED turns on), and then the key with the character or function printed above it (LED stays on).	On the alphanumeric keypad, press  , then press M to type the number 9.
Use a green character or function printed above a key.	 (LED turns on), and then the key with the character or function printed above it (LED stays on).	On the numeric keypad, press  , then press 3 twice to type the letter “e”.
Unlock the green or orange key.	 or  once.	Press  or  once to unlock the key. The LED turns off.



How to Capitalize Characters on the QWERTY Keypad

If your CN51 has the QWERTY keypad, you can capitalize characters individually, or you can type all capital letters by enabling Caps Lock:

- To capitalize a single character, press the **Shift** key, and then the character.
- To enable Caps Lock, press  and then press the **Shift** key.
- When Caps Lock is enabled, press  and then press the **Shift** key to disable Caps Lock.

How to Capitalize Characters on the Numeric Keypad

If your CN51 has the numeric keypad, you can capitalize characters individually, or you can type all capital letters by enabling Caps Lock:

- To capitalize a single character, press the  key, and then the **1** key. Select the key with the letter you want to capitalize. Press **1** again to return to lowercase letters.
- To enable Caps Lock, press  and then press **1**.
- To disable Caps Lock, press **1** again.

About the Power Button

Press the **Power** button quickly to suspend the computer, or to resume where you left off when you last suspended the computer. When you suspend the computer this way, the phone can still receive incoming calls.

To select a power mode, press and hold the **Power** button, and select a power mode from the list that appears:

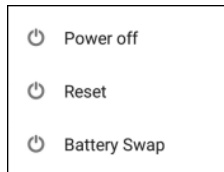

- **Power off:** Turns the computer off, including the phone. The computer will not receive incoming calls.
- **Reset:** Performs a system reset. The computer restarts after a reset, and you may lose data in open apps. All your settings are saved during a reset.
- **Battery Swap:** Turns power off to the computer but saves your settings while you install a charged battery. When you press Power after installing the charged battery, the computer resumes where you left off prior to entering battery swap mode.

About the Screen Backlight

The display has an ambient light sensor that automatically adjusts the backlight intensity to conserve power and ensure the display is readable. You can set the backlight intensity level as needed for your environment.

Configure the Screen Backlight Brightness

You configure the screen backlight brightness in the Settings app.

- 1 Start the Settings app and tap **Display**.
- 2 To set the brightness level manually, tap **Brightness level** and adjust the slider to set the brightness level.

Or, to automatically adjust the brightness for your work environment, tap **Adaptive brightness**.

About the Audio Features

Your mobile computer has a speaker, a microphone, and several software tools for configuring the volume of sounds.

Adjust the Ringtone and Notification Volume

You can quickly adjust the volume of ringtone and notification sounds by using the side volume buttons.



Note: This method only affects the volume of ringtone and notification sounds. To change the volume for other sounds, in the Settings app tap **Sound & notification** > **Volumes**.

Chapter 1 – About the Computer Features

- 1 Press one of the right side buttons. The Volume slider appears.



- 2 Press the right side buttons or adjust the slider to change the volume.

Or, to adjust the ringtone and notification volumes separately, tap the arrow and adjust the sliders in the menu:

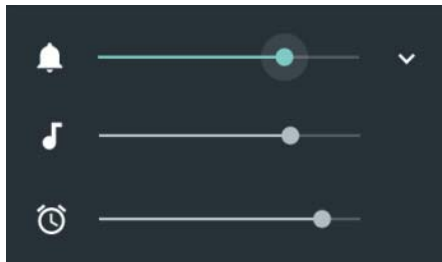

Enable Vibrate Mode

You can quickly enable Vibrate mode if necessary for your working environment.

- 1 Press one of the right side buttons. The Volume slider appears.
- 2 Press the bottom right side button or adjust the slider to turn the volume all the way off. The Vibrate mode icon appears.

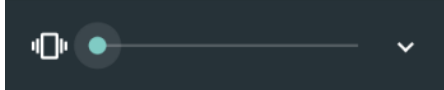

To enable alarms only, press the bottom right side button once. This message appears:

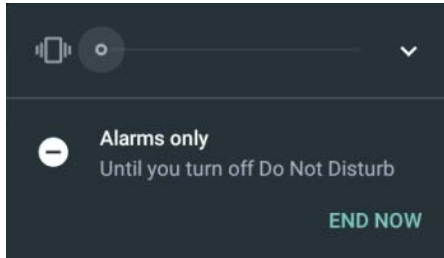

Tap **END NOW** to turn off alarms-only mode.

Audio Settings

This section describes the audio and sound settings you can configure in the Settings app. To change audio settings, start the Settings app and tap **Sound & notifications**.

Audio and Sound Settings

Setting	Description
Volumes	Use the sliders to set the volume for: <ul style="list-style-type: none">• music, video, games, and other media• alarms• ringtone and notifications. You can also use the side volume buttons to change the volume.
Vibrate when ringing	Select to enable vibrate mode when the phone is ringing.
Do not disturb	Select this mode to set what kinds of alarms, notifications, events, or selected callers are allowed to interrupt Do not disturb mode.
Phone ringtone	Select a ringtone.
Default notification ringtone	Select a notification sound.
Dial pad touch tones	Select to enable audio tones when you use the phone keypad.
Screen lock sound	Select to enable an audio tone when the screen is locked.
Charging sounds	Select to enable an audio tone when the computer is charging.
Touch sounds	Select to enable audio sounds when you use the touch screen.
Vibrate on touch	Select to enable vibrate mode when you touch the screen.

Insert a microSD Card

You can use a micro Secure Digital (SD) card to increase file storage capacity or to install software. The CN51 supports an optional microSD™ card (up to 32 GB maximum capacity). The card slot is located in the battery compartment.

- 1** Remove the battery and open the card access door in the battery compartment.
- 2** Slide the SIM card holder to the left to unlatch it, and lift the holder to open it and access the microSD card holder.

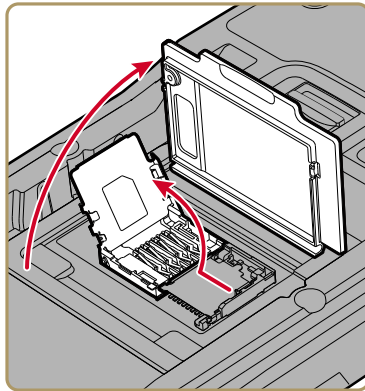

- 3** Slide the microSD card holder towards the top of the CN51 to unlatch it, and lift the holder to open it.

Chapter 1 – About the Computer Features

- 4 Place the microSD card in the holder with the contacts facing away from the holder.

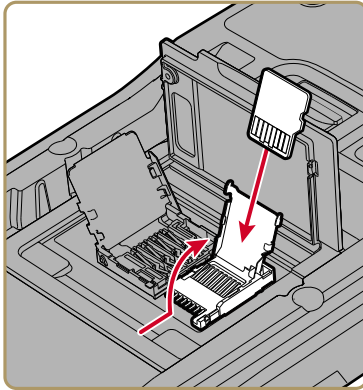

- 5 Close and latch the microSD card holder.

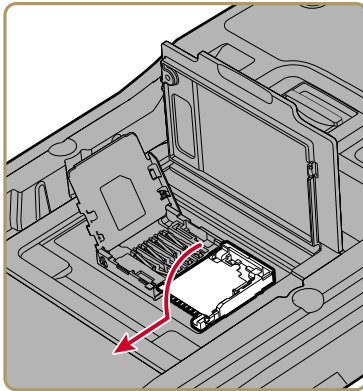

- 6 Close and latch the SIM card holder, and close the card access door until it snaps shut.
- 7 Install the battery and turn on the computer.

To verify that the card is installed correctly, start the Settings app and tap **Storage**. Look in the SD card section for more information.

If you have a file browsing app, you should now be able to navigate to the microSD card and view the contents of the card.

How to Transfer Files

To transfer files you need to physically connect the mobile computer to your desktop PC through a USB connection. When the computer is connected through USB, you can browse to it and drag-and-drop to move files back and forth to a Windows PC. If you are transferring files to and from a Mac, use the Android File Transfer application (available from www.android.com/filetransfer).



Note: File transfer through a USB connection is disabled by default. You need to configure the USB connection for transferring files or photos.

Configure the USB Connection for Transferring Files

By default, transferring files from the computer to a PC through a USB connection is disabled. Before you can transfer files, you need to change the connection settings.

- 1 In the main screen, swipe down to view the Notifications.

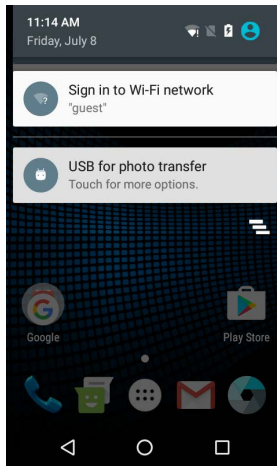

2 Tap USB for charging. This menu appears:

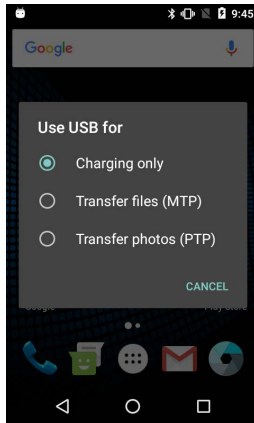

3 Tap Transfer files (MTP). Or, if you will be transferring mainly photos, tap **Transfer photos (PTP)**. The USB settings are changed.

To verify the change, swipe down to view the Notifications.

CN51 Accessories

The CN51 ships with a battery. All other accessories are sold and ordered separately. For help, contact your local sales representative.

CN51 Accessory Descriptions

Accessory	Description
CN51 AC Power Adapter (Model AE37)	The CN51 AC Power Adapter provides a connection for external AC power to the CN51. To use this adapter, you need to purchase a country-specific power cord.
CN51 Battery (Model 1015AB01)	The battery provides power to the CN51. Keep a spare battery pack on hand for longer shifts.
CN51 Charge-Only Multidock (Model AD23)	Use the charge-only multidock to hold up to four CN51s with batteries installed, charge batteries, and provide power to the computers.
FlexDock: DX4 Quad Dock	Use the DX4 Quad Dock to charge up to 4 computers and batteries simultaneously. The Quad Dock is available in Ethernet and charge-only versions.

CN51 Accessory Descriptions (Continued)

Accessory	Description
CN51 Ethernet Multidock (Model AD24)	Use the multidock to hold up to four CN51s with the batteries installed. The multidock charges the batteries and provides power and Ethernet connections to each computer.
CN51 Replacement Handstrap	Use a replacement handstrap to replace a worn-out or lost handstrap.
CN51 Magnetic Stripe Reader (Model AR9)	This accessory snaps on to the CN51 and provides magnetic stripe reading capabilities.
CN51 Quad Charger (Model AC21)	Use the quad battery charger to charge up to four batteries.
CN51 RS-232 Adapter	This accessory snaps on to the CN51 and provides serial connectivity.
CN51 Single Dock (Model AD27)	Use the single dock to hold a CN51 with its battery installed, charge a spare battery pack, charge the main battery pack, and provide power to the mobile computer. The dock has USB host and client connectors. Optional adapters are available to convert the USB host to Ethernet or to a landline modem.
Ethernet Adapter (Model 1004UA01)	Use this Ethernet adapter with the Model AD27 Single Dock to connect the CN51 to your Ethernet network.
Modem Adapter (Model 1004UA02)	Use this modem adapter with the Model AD27 Single Dock to connect the CN51 to a landline modem.
CN51 Tethered Stylus Replacement	Use a replacement stylus to replace a lost or broken stylus.
CN51 Vehicle Docks (AV6, AV9)	Use the vehicle docks to hold and charge the CN51 while using it on a vehicle.
CN51 Vehicle Power Adapter (Model AE36)	Use the vehicle power adapter to charge the battery installed in the CN51 from your vehicle.

2

About the User Interface and Honeywell Applications

Use this chapter to learn about the Android user interface and how to interact with the screen. You can also use this chapter to learn about the Honeywell applications on your computer, as well as additional applications you can download.

About the User Interface

The Android 6.0 operating system provides a touch-friendly and easy to navigate user interface.

About the Home Screen

When you turn on the mobile computer, the Home screen is the first screen that appears after language provisioning is complete.

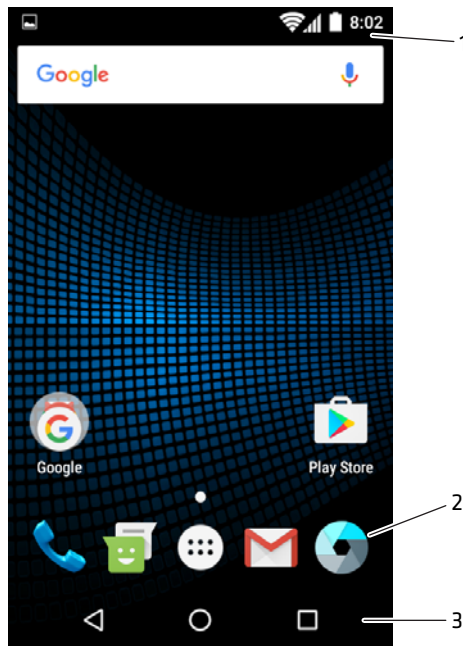

Home Screen Icons and Navigation

Item	Description
1	Status and system icons. Status icons to the left tell you when an app has sent notifications, such as an arriving message or a meeting notice. System icons to the right display the current wireless and network connection state and battery level.
2	Favorites tray. App icons in the tray are visible on every Home screen. The All Apps icon is always in the center of the Favorites tray.

Home Screen Icons and Navigation (Continued)

Item	Description
3	Navigation buttons: <ul style="list-style-type: none">◀ - Back button. Tap to return to the previous screen, even if that screen was in a different app.⊙ - Home button. Tap to return to the Home screen. If there are multiple Home screens, tap to return to the center Home screen.◻ - Recent Apps button. Tap to return to the previous screen, even if it was in a different app.

View Notifications

- Swipe down from the top of the screen. The notifications shade includes a list of events.

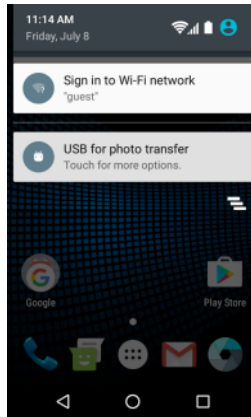

To close the shade, swipe up from the bottom of the screen, or tap the Back or Home buttons.

Customize the Home Screen

You can add application icons to any Home screen to access them more easily.

- 1 Touch . The All Apps screen appears.

- 2 To add an app icon to a Home screen, touch and hold the icon for the app, and then slide your finger to place the icon on one of the Home screens.

To add a widget icon to a Home screen, touch **WIDGETS** at the top of the screen, touch and hold the icon for the widget, and then slide your finger to place the widget icon on one of the Home screens.

- 3 To remove an app or widget from the Home screen, touch and hold the icon and slide it over **Remove** at the top of the screen.

Customize the Favorites Tray

You can add application icons to the Favorites tray to access them more easily.

- 1 Touch . The All Apps screen appears.
- 2 Touch and hold an icon in the Favorites tray, and slide it over **Remove** at the top of the screen.
- 3 To add an app icon to the Favorites tray, touch and hold the icon for the app, and then slide your finger to place the icon in the Favorites tray.

To add a Widget icon to the Favorites tray, touch **WIDGETS** at the top of the All Apps screen, touch and hold the icon for the widget, and then slide your finger to place the icon in the Favorites tray.

Use Google™ Search

Use the Google search field at the top of the Home screen to help you find anything you need on the computer or on the web.

- 1 At the top of any Home screen, touch **Google** to type your search term. As you type, suggestions from Google web search appear below the search box, and results from the computer (such as apps or contacts) appear below the web search results.
- 2 Tap a suggestion to search for it immediately, or touch its arrow just to add the term to the search field without starting to search.

About Screen Gestures

Use your fingers or the stylus to manipulate icons, buttons, menus, the onscreen keyboard, and other items on the screen.

- To select or activate something, tap it.
- To type something, such as a name or password, touch where you want to type. A keyboard appears that lets you type into the field.

Other common gestures include:

- **Touch and hold:** Touch and hold an item by touching it and lifting your finger until an action occurs.
- **Drag:** Touch and hold an item for a moment. Without lifting your finger, move your finger on the screen until you reach the target position. For example, you can drag to reposition shortcuts on the Home screen.
- **Swipe or slide:** Quickly move your finger across the screen, without pausing when you first touch. For example, you can slide a Home screen left or right to view the other Home screens.
- **Double-tap:** Tap quickly twice on a webpage, map, or other screen to zoom in. Double-tap again to zoom out.
- **Pinch:** In some apps, you can zoom in and out by placing two fingers on the screen at once and pinching them together (to zoom out) or spreading them apart (to zoom in).

Set the Time Zone

The CN51 gets the current date and time from its network connection. You can manually set the time zone for your location.

- 1** Start the Settings app.
- 2** Tap **Date & time**.
- 3** Disable **Automatic time zone**.
- 4** Tap **Select time zone** and select the time zone for your location.

Manage Notifications







When an app sends a notification to the computer, you can easily respond to it.









- 1 When notification icons appear, swipe down from the top of the screen.
- 2 To respond to a notification, touch it. The associated app opens so you can respond.

To dismiss a notification, swipe it sideways.

About Honeywell Applications

Honeywell applications help you troubleshoot and connect your computer to other devices and networks. Many of the applications in this table are located in the Power Tools folder. For more information on Power Tools, look for Dolphin Power Tools on www.honeywellaidc.com.

Icon	Application	Description
	ConfigApps	Provides a way to disable/enable apps and uninstall updates.
	AutoInstall Settings	Use to automatically install packages, APKs, and configure during the boot sequence.
	Configure Autorun	Configure which applications you want to run during the boot sequence.
	Backup	Backup and restore settings and user data.
	BattMon	Monitor the charge status of the battery.
	Demos	Use ScanDemo to demonstrate how the scanner works. You can use it to scan a bar code, set the symbologies it scans, and determine the computer response to a scanned bar code.

Icon	Application	Description
	Diagnostic Information	Use the DiagnosticInfo app to view device information, Honeywell Apps, Radio Information, Battery Information, Memory Information, and Scanner Information.
	EZConfig	Configure the device and applications efficiently with bar code and configuration files.
	File Browser	Provides an efficient way to browse files on the computer.
	IPConfig	Use IPConfig to view network adapter information.
	LogView	Displays LogCat and Dmesg information in real time.
	Ping	Use Ping to verify communication links or to make sure a specific IP address is working.
	Route	Use Route to view and edit the rules that govern how packets destined for various subnets are routed.
	Wi-Fi Info	Provides Wi-Fi information on the computer.

Unlock Developer Options

If you are an application developer, unlock the Developer options to easily test and debug your apps. After you unlock the options, a link to Developer options appears in the System menu.

- 1 Start the Settings app.
- 2 Tap **About phone**.
- 3 Tap **Build number** seven times. A popup message appears informing you that you are now a developer.

3

Use the Scanner

This section describes how to use and configure the scanner to scan bar codes.

About the Scanner

The internal scanner can read 1D and 2D bar code symbologies, composite symbologies, and postal codes.

How to Scan Bar Codes as Keyboard Input

The scan wedge feature sends scanned bar code data to an active application as Android keypad input. To scan a bar code as keyboard input, open an application that accepts text input and then scan a bar code. By default, scan wedging is enabled on the computer.

You can use applications that are coded to use the scanner or applications that receive data through the scan wedge feature. If an application claims the scanner through the BarcodeReader API, the scan wedge feature is temporarily disabled. You can find information on how to create custom applications for the computer in the Honeywell Mobility SDK for Android, available from Honeywell Technical Support.

Change the Scanner Settings

Changes you make to the Default profile apply to all applications with no profile.

- 1** Tap **All Apps > Settings**.
- 2** Tap **Scanning**.
- 3** Tap **Internal Scanner > Default Profile**.
- 4** Select a settings group and modify the settings to meet your application needs.

Restore Default Scanner Settings

You can easily discard all changes you made to the Default profile and restore the default values.



Note: When you select to restore the default values of one of the settings, it also restores the default values of all settings within the profile.

- 1 Tap  in the upper right corner of any of the scanner settings screens.
- 2 Tap **Restore all defaults**.

Scan Bar Codes

All of the scanners have an aiming beam to help you correctly frame bar codes and they support omni-directional (360°) scanning.



Note: Before you start scanning bar codes, use the Settings app to enable only the bar code symbologies that you need.

- 1 Point the scanner window at the bar code and hold the computer steady a few inches from the label.
- 2 Press the **Scan** button or pull the scan handle trigger. The illumination beam, laser pointer, or frame appear.

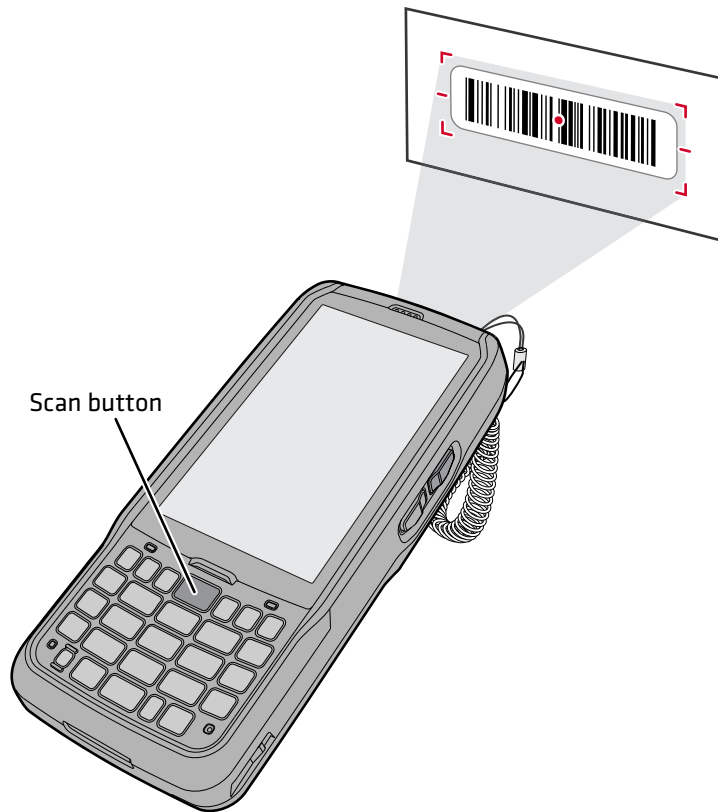

For near or close-in scanning distances of 30 cm (11.8 in) or less, use the laser pointer as a guide and aim slightly to the right of the center of the bar code. Make sure the illumination beam covers the bar code you are trying to decode.

For standard and long range scanning distances of 30 cm (11.8 in) or more, use the laser pointer as a guide and aim toward the middle of the bar code. Make sure that the illumination beam covers the bar code you are trying to decode.

When the scanner successfully reads a bar code label, you hear a high beep, and the Good Read LED turns on briefly.

- 3** Release the **Scan** button or trigger.



Use the Scan Demo App

Use the Scan Demo app to read bar codes, or to test your symbology decode settings.

- 1 In the All Apps screen, tap **Demos**. The Features Demo app runs.
- 2 In Features Demo, swipe the turntable to bring the bar code to the front. When the bar code turns into a box with a QR Code, tap the box. The Scan Demo feature runs.
- 3 Aim the scanner window at the bar code and press **Scan**, or pull the scan handle trigger.

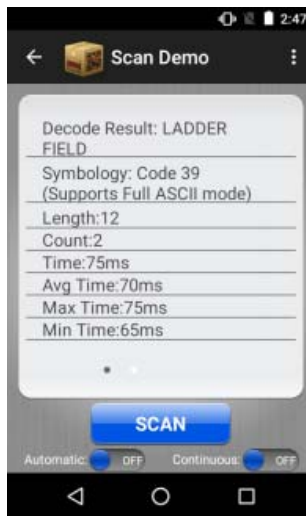
When the scanner successfully scans the bar code, you hear a high beep, and the Good Read LED turns on briefly. A list of bar code information appears.



- 4 To clear all scanned bar code information, tap  and select **Clear All**.
- 5 To enable or disable decoding for specific symbologies:
 - a Tap  and select **Symbology Settings**.
 - b Tap the symbology name to enable decoding for that symbology, or to clear the check box and disable decoding.

4

Use the Phone

You can use the phone feature to make and receive telephone calls, as well as transmit data through cellular wide-area networks (WANs).

About the Phone

Phone features on the computer include a speaker and a microphone. You can also use a Bluetooth headset or hands-free kit. The phone feature is enabled by default.

The WAN radio in your computer determines the supported network types:

- If your computer includes the UMTS/HSPA+ WAN radio, you can connect to UMTS networks.
- If your computer includes the Flexible Network Radio, you can connect to CDMA or UMTS networks in all regions that support these technologies. The Flexible Network Radio is a software-defined radio (SDR) that can be configured for CDMA or UMTS depending on your wireless communication needs.

Honeywell supports Verizon and Sprint in the United States (only) as a CDMA network carrier. For other carriers, contact Honeywell Technical Support.

After you turn on the phone and activate service with your wireless carrier, you can customize the phone features and network settings in the Wireless & Networks section of the Settings app.



Note: Both WWAN radios support Network Information and Time Zone (NITZ) messages to automatically set the system time.

Activate the UMTS Phone

Activating the UMTS phone on your CN51 is done the same way whether your computer has the Flexible Network Radio or the UMTS/HSPA+WAN radio.

You use a SIM card to activate the UMTS phone on the CN51. You can purchase the SIM card from your network provider.

- 1 Press **⓪** to turn off the CN51.
- 2 Disconnect the handstrap from the top of the computer.

- 3** Push forward on the battery release tab until the battery releases, and then lift the battery away from the computer.

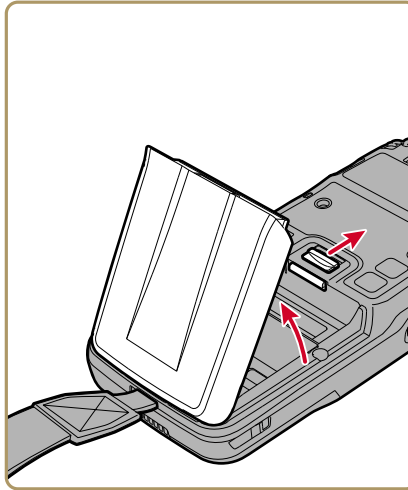

- 4** Open the card access door and slide the SIM card holder to the left to open it.

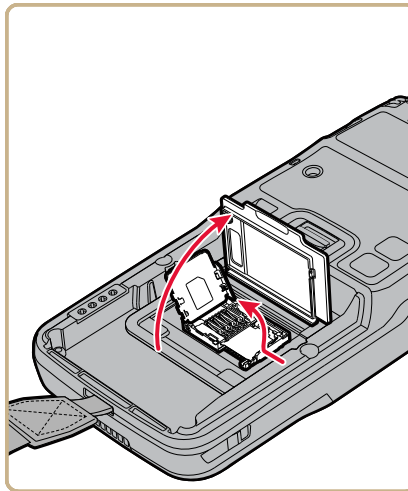

- 5 Place the SIM card in the holder.

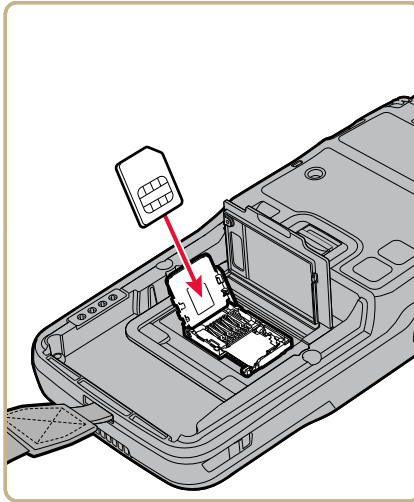

- 6 Close the SIM card holder and slide it to the right to secure it, and then close the card access door.

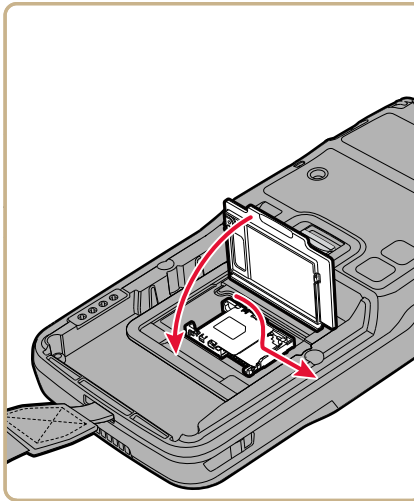

- 7 Insert the battery and press down until it clicks in place.
- 8 Reconnect the handstrap.
- 9 Press **Ⓜ** to turn on the CN51. The phone is now ready to use.

Activate the CDMA Phone

To activate the CDMA phone in your mobile computer, you need to contact your wireless carrier and set up an account.

You also need to provide the carrier with the Mobile Equipment Identifier (MEID) for the computer. You can find the MEID:



- on a label located in the battery compartment.
- on the outside of the computer shipping box.



Note: For the CDMA phone, settings are permanently stored in the WAN radio after activation. CDMA settings persist through a factory data reset.

The activation process is slightly different for each CDMA carrier. In general, you need to contact your wireless provider and give the provider the MEID for the computer.





Note: If your carrier is Verizon, tap , enter *228 on the phone keypad, and tap . After a short wait, a message appears, confirming either success or failure of the activation. After successful activation, the phone is ready to use.

Make a Phone Call

Once the phone is activated, you can make a phone call.

- 1 On the Home or All Apps screen, tap .

If the Phone app opens to a list of numbers instead of the keypad, swipe left or touch  to return to the keypad.

- 2 Touch the keys to enter the number, and then touch  below the keypad to dial.
- 3 To end a call in progress, tap .

Answer the Phone

When you receive a phone call, the Incoming Call screen opens, showing the caller ID. All incoming calls are recorded in the Call log. If you miss a call, you receive a notification.

- When a call arrives, touch the white phone icon and slide over one of the icons:

To answer the call: 

To send the call to voicemail: 

To send a message from a list of default text messages: 

Send a Call to Voicemail

When you receive an incoming call, you can send the call to voicemail instead of answering it.

- When a call arrives, touch the white Phone icon and slide over  to send the call to voicemail.

Switch Apps During a Phone Call

You can switch apps while a phone call is in progress. For example, you can use the People app to look up contact information during your call.



Note: If you have only a WAN connection, apps that need a data connection may be unable to access online data while the phone call is in progress. If simultaneous phone calls and data connections are not possible due to provider limitations, voice calls receive priority. Check with your provider for more information.

- During a phone call, tap another app icon on the Home or All Apps screen to run that application. The green Phone icon appears in the Status bar while the call is underway.

Check Your Voicemail

When you have a new voicemail message, the voicemail icon appears at the top left of the screen.



Note: Consult your service provider for more information on setting up your voicemail account.



- 1 Swipe down from the top of the screen to view your notifications. The voicemail notification shows the number of unread messages and a number to dial.
- 2 Touch **New voicemail**. The phone dials the number. Follow the instructions to retrieve your messages.

Set Your Voicemail Number



To access your voicemail, you must set your voicemail number in the Phone app.



Note: Verizon customers do not need to follow this procedure.

- 1 Tap .
- 2 Tap  and then tap **Settings**. A list of call settings appears.
- 3 Tap **Calls > Voicemail > Setup > Voicemail number**.
If you are an AT&T customer, enter your voicemail number.
- 4 Tap **OK**.

Change Voicemail Settings

- 1 Tap  on a Home or All Apps screen.
- 2 Tap  and then tap **Settings**.
- 3 Tap **Calls > Voicemail**.
- 4 Tap the voicemail setting you want to change.

Make an Emergency Phone Call

You can use the phone to make an emergency phone call, even if the SIM card is missing from your UMTS phone or if you do not have a valid CDMA account. In either case, the phone shows that you have no service. However, if you dial certain emergency numbers (such as 112, 911, 000, 08, 118, 119, or 999) the call will go through.

Switch Between Network Carriers

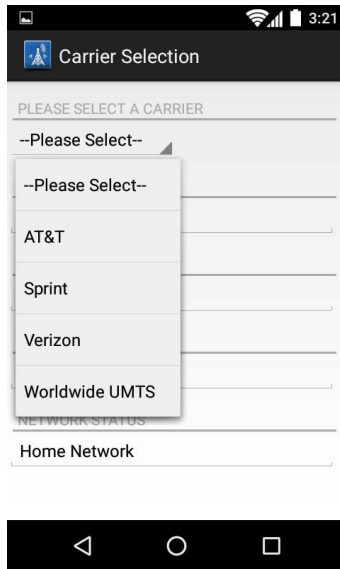

If your computer includes the Flexible Network Radio, you can easily add carriers and switch between them as needed.

- 1 In the All Apps screen, tap **Carrier Selection**.
- 2 Select a different carrier from the **Please select a carrier** list.



Configure Phone Settings

You can customize settings for the phone, including the ringtone, voicemail options, keypad tones, internet call settings, and other options.

- 1 Tap .
- 2 Tap  and then tap **Settings**. The Call settings menu appears.
- 3 Change phone settings as necessary.

5

Use the Camera



Learn to use the color camera to take pictures and record videos.

About the Color Camera

The computer includes a 5.0-megapixel camera for taking pictures and videos. The camera and flash are located on the back of the computer.



Use the Photos app  to view photos and videos stored on the computer.

Take a Picture

- 1 In the All Apps screen, tap **Camera** .
- 2 Using the screen as a viewfinder, move the computer until you see the image you want.
- 3 Tap the screen to set the focus. By default, the camera senses the lighting in the environment and turns the torch on if needed.
- 4 Press **Enter** or tap the Camera button . The camera takes a picture and a thumbnail image of the picture appears:
 - To view the picture, tap the thumbnail image or swipe to the left.
 - To return to the Camera app, swipe the thumbnail image to the right.

Change Camera Settings

You can change the camera settings for best results when taking pictures.

- 1 In the All Apps screen, tap **Camera** .
- 2 Tap  to view the camera options.



- 3** Tap one of the icons to change basic camera settings:
 - **Timer:** Set the amount of time from when you tap the Camera icon until it takes a photo. Options for the timer are 3 seconds or 10 seconds.
 - **Grid:** Turn on a grid to help you frame your photos. Options for the grid are enabled or disabled.
 - **Flash:** Turn on the flash to take photos in low light conditions. Options for flash are on, off, and automatic.

Record a Video

This section explains how to record video with the camera in the computer.

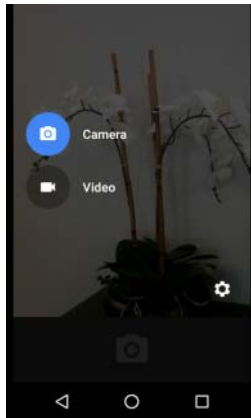
- 1** In the All Apps screen, tap **Camera** .
- 2** When the Camera screen appears, swipe to the right. This menu appears:





- 3** Tap . The Video screen appears.
- 4** Tap  to begin recording video.
- 5** When you are done recording, tap .

Change Video Settings

You can change the camera settings for best results when recording video.

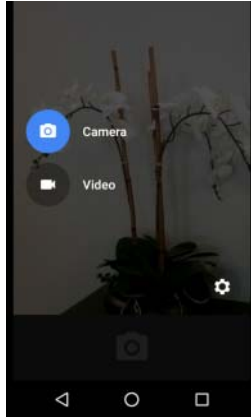
- 1 In the All Apps screen, tap **Camera** .
- 2 When the Camera screen appears, swipe to the right. This menu appears:



- 3 Tap .
- 4 Tap  to view the video options.
- 5 Tap the grid or the flash icon to turn the option on or off.

6

Configure the Computer

Use this chapter to learn about the available methods for configuring your computer. You can also use this chapter to learn how to configure network communications and wireless security.

How to Configure the Computer

You can configure many parameters on the computer such as the bar code symbolologies it decodes, or the network settings. The values you set for these parameters determine how the computer operates.

You configure the computer using the Settings app.

Start the Settings App

The Settings app is located in the All Apps menu.

- Tap **All Apps > Settings**.

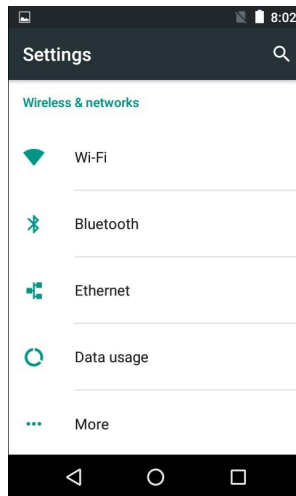

About the Structure of the Settings App

Use this section to learn about the structure of the Settings app so you can find parameters quickly.

Wireless & Networks

Setting	Description
Wi-Fi	Turns the Wi-Fi radio on and off. When Wi-Fi is turned on, tap the bar to see a list of Wi-Fi networks.
Bluetooth	Turns the Bluetooth radio on and off. When Bluetooth is turned on, tap the bar to see a list of Bluetooth devices in range.

Wireless & Networks (Continued)

Setting	Description
Ethernet	Turns Ethernet on and off. When Ethernet is turned on, you can change the Ethernet settings and set up a proxy.
Data usage	Displays a list of phone data usage for the current data usage cycle. Tap the Data usage cycle list to select another date range.
More	<p>Airplane mode: Turns airplane mode on and off.</p> <p>Tethering & portable hotspot: Allows you to use the computer as a portable Wi-Fi hotspot and enables Bluetooth or USB tethering.</p> <p>VPN: Sets the password parameters for a virtual private network (VPN).</p> <p>Cellular networks: Includes settings for mobile networks, including enabling data access and roaming over mobile networks, selecting access points and network operators, or selecting only 2G networks (to save battery life).</p> <p>Mobile plan: Provides information on your cell phone plan.</p>

Device

Setting	Description
Display	Settings for the brightness, wallpaper, sleep, Camera button option, daydream, font size, and screen auto-rotation.
Sound & notification	Settings for the phone and notification sounds, including tones and volume.
Apps	Lists downloaded and running apps.
Storage & USB	Shows the remaining amount of storage.
Battery	Shows battery usage data and the current battery state.
Memory	Shows the average memory use and the memory used by apps.
Users	Shows the users of the computer. You can easily add a user or profile.

Honeywell settings

Setting	Description
Battery LED	Settings for the battery LED. Use the Honeywell default LED, the Android default LED, or disable the LED.
Battery info	Shows battery information, including status, serial number, health, voltage and current, and other useful data.
Logger	Enable or disable a logging service that creates an Android logcat log and kernel log for app and system troubleshooting.
Key Remap	Remap the scan buttons or set a push-to-talk (PTT) button.
Scanning	Configures the imager.
Web applications	Enables the web interface settings and lets you set a port.

Personal

Setting	Description
Location	Turns location services (Google and GPS satellite data) on and off.
Security	Sets screen lock and administrator privileges.
Accounts	Adds a corporate or email account to the computer.
Google	Sets up Google accounts and services.
Language & input	Selects the active language and default keyboard. Sets auto-typing features such as capitalization and punctuation. Adjusts the pointer speed for an external mouse or trackpad.
Backup & reset	Restores factory default settings.

System

Setting	Description
Date & time	Configures all date and time settings.
Accessibility	Sets accessibility levels, such as larger display text and enabling text-to-speech output.
Printing	Configure the printing options.

System (Continued)

Setting	Description
Developer options	Enables developer-specific options such as USB debugging and SD card protection.
About phone	Lists device-specific settings including the phone number, operating system version, and build number.

About Network Communications

You can use the mobile computer in your wireless or wired data collection network. You can connect your computer using:

- 802.11 radio communications.
- Ethernet communications.
- Bluetooth communications.
- USB and serial communications.

Connect to a Wi-Fi Network

The CN51 has an 802.11 radio to transfer data using wireless communications. Before you connect to a Wi-Fi network, you need to know about your network security protocol and its required credentials.

By default, the 802.11 radio is disabled.

- 1 In the Settings app, tap **Wi-Fi** and slide the Wi-Fi switch on. The switch turns blue and a list of discovered networks appears.

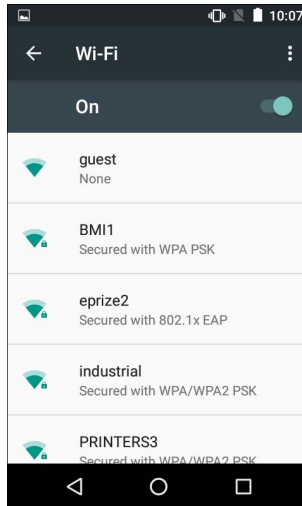

- 2 To add a network to the list, tap , tap **Add network**, type the network name, and then tap **SAVE**.
- 3 Tap a network name in the list to view details:

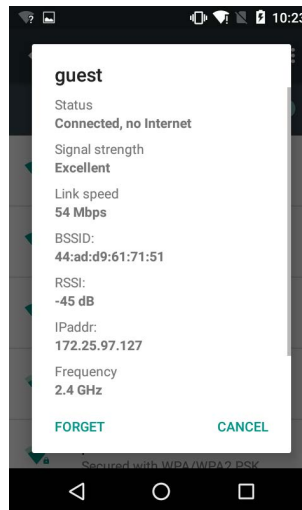

If the network is secured, a list of required information appears (such as a certificate name, a password, or other credentials). To connect to the secured network, enter the required information and tap **Connect**.

To leave a connected network, tap **Forget**. For example, you could choose to forget a network you no longer use.

To close the network details screen, tap **Cancel**.

Configure Proxy Settings for a Wi-Fi Network

If you need to connect to network resources through a proxy server, you can configure settings for the proxy server for each Wi-Fi network you add. By default, the Wi-Fi networks you add are not configured to connect through a proxy server.



Note: Proxy settings apply only to the Wi-Fi network you modify. You must change proxy settings for each network requiring a proxy server.

- 1** Open the Settings app and tap **Wi-Fi**. The list of available Wi-Fi networks appears.
- 2** Tap and hold the network name and then tap **Modify network**. A list of network settings appears.
- 3** At the bottom of the list of network settings, select **Advanced options**.
- 4** If the network has no proxy settings, tap **None** in the Proxy Settings list, and then tap **Manual** in that list.
- 5** Enter the proxy settings for the network.
- 6** Tap **Save**.

Disable Wi-Fi Notifications

By default, when Wi-Fi is enabled, you receive notifications in the Status bar when the computer discovers a wireless network. You can disable these notifications.

- 1 Start the Settings app and tap **Wi-Fi**.
- 2 Tap  and then tap **Advanced**. The Advanced Wi-Fi menu appears.
- 3 Tap the **Network notification** slider to disable notifications.

Connect to an Ethernet Network

To connect the computer to an Ethernet network, you need an Ethernet dock.

- 1 Make sure the dock is connected to your Ethernet network.
- 2 Place the computer in the dock.
- 3 Start the Settings app and make sure Ethernet is enabled (Ethernet is enabled by default).

To enable Ethernet, slide the Ethernet switch on. When the switch turns blue, Ethernet is enabled.

- 4 Tap **Ethernet**. The Ethernet list shows the name of the current Ethernet connection. By default, the computer assumes a DHCP connection, and that your network has assigned an IP address automatically. If DHCP is working, the Ethernet dock should indicate that communication with the network is occurring.
- 5 (Optional) To assign a static IP address, tap the connection name (for example, eth0). The IP settings dialog box appears.
 - a Tap **DHCP** and then select **Static** from the list.
 - b Enter the required network information and then tap **Apply**.

How to Connect to Virtual Private Networks

The computer supports connecting to virtual private networks (VPNs). This section describes how to add and connect to VPNs.

To configure VPN access, you must obtain details from your network administrator. You view and change VPN settings in the Settings app.



Note: Before you can access VPNs, you must set a screen lock method.

Add a VPN

Before you can connect to a VPN, you must add VPN information.



Note: Before you can add or connect to a VPN, you must set a screen lock method.

- 1 In the Wireless & Networks section of the Settings app, tap **More**.
- 2 Tap **VPN**.
- 3 Tap . The Edit VPN Profile screen appears.
- 4 Enter information for the VPN.
- 5 Tap **Save**. The VPN name appears in the VPN list.

Connect to a VPN

- 1 In the Wireless & Networks section of the Settings app, tap **More**.
- 2 Tap **VPN**.
- 3 Tap the name of the VPN in the list, and enter any necessary credentials when prompted.
- 4 Tap **Connect**. The computer connects to the VPN, and a Status icon and notification appear.

To disconnect from the VPN, tap the notification.

Edit VPN Information

- 1** In the Wireless & Networks section of the Settings app, tap **More**.
- 2** Tap **VPN**.
- 3** Tap and hold the name of the VPN you want to edit, and select **Edit VPN profile**.
- 4** Edit VPN settings as necessary.
- 5** When you are done, tap **Save**.

About Wireless Security

The computer provides these security solutions for your wireless network:

- Wi-Fi Protected Access 2 (WPA2™)
- Wi-Fi Protected Access (WPA)
- 802.1x
- LEAP
- WEP

Honeywell recommends WPA2 security with PSK (Personal) or 802.1x (Enterprise) key management.

Before you set security, you need to enable the radio, set the date, and set the SSID on your computer. To use 802.1x security, you need to load a root certificate on your computer. To use transport layer security (TLS) with 802.1x security, you also need to load a user certificate.

Configure Wireless Security

Use the Settings app to access and configure all wireless security settings.

About Certificates

You can use digital certificates to identify the computer for network access or authentication to servers. To use a certificate to identify your device, you must install it in the trusted credential storage on the computer.

Android supports DER-encoded X.509 certificates saved in files with a .crt or .cer file extension. To install a valid certificate with a .der or other extension, you must change the extension to .crt or .cer to install it.

Android also supports X.509 certificates saved in PKCS#12 key store files with a .p12 or .pfx extension. To install a valid key store file with another extension, you must change the extension to .p12 or .pfx to install it. When you install a certificate from a PKCS#12 key store, Android also installs any accompanying private key or certificate authority certificates.

Load a Certificate

To use a certificate, you must install it in the trusted credential storage on the computer.



Note: Apps such as Email and Browser that support certificates allow you to install certificates directly from within the app. For more information, see the Help that comes with the app.

- 1 Copy the certificate or key store from your PC to a microSD card.
- 2 Install the microSD card in the computer and turn the computer on.
- 3 Start the Settings app and tap **Security > Install from SD card**.
- 4 Tap the name of the certificate or key store to install it. If prompted, enter the key store password and tap **OK**.
- 5 Enter a name for the certificate and tap **OK**.

Disable or Remove Certificates

If a certificate is compromised, or your organization chooses not to trust it, you can disable or remove it.

- 1 Start the Settings app and tap **Security > Trusted credentials**.

The trusted credentials screen has two tabs:

- **System** shows CA certificates that are installed in the ROM.
- **User** shows CA certificates you have installed yourself.

- 2 Tap the name of the certificate to disable or remove. The certificate details screen appears.

- 3 Scroll to the bottom of the details screen and tap **Disable** (for System certificates) or **Remove** (for User certificates).



Note: If necessary, you can enable a disabled System certificate from this location. If you remove a User certificate, you must install it again to enable it.

- 4 Tap **OK**.

About Bluetooth Communications

The CN51 is Bluetooth-enabled, which lets you connect to other Bluetooth devices.

You need to turn on the Bluetooth radio before you can discover and connect to Bluetooth devices. By default, the radio is turned off.

The Bluetooth radio maintains its current state through a system reset. If you perform a factory data reset, you must recreate pairings to devices.

System bar icons indicate Bluetooth status.

Connect a Bluetooth Device

To connect to a Bluetooth device, you must enable Bluetooth and then select the device from a list of discovered devices.

- 1 Start the Settings app.
- 2 If Bluetooth is off, slide the Bluetooth switch on. A list of available Bluetooth devices appears.

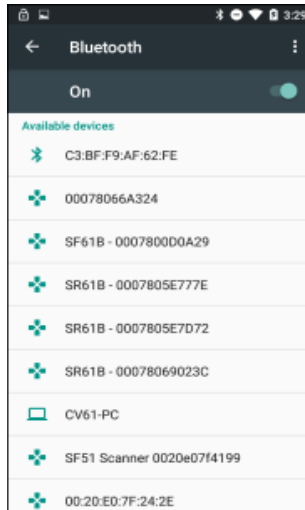

- 3 (Optional) If the device you want does not appear in the list, make sure the device is turned on and discoverable, tap , and then tap **Refresh**.

- 4 Tap a device in the list to select it. If a pairing request message appears, enter the device PIN and tap **OK**. When the device is paired with the computer, the device name appears in **Paired Devices** at the top of the list.

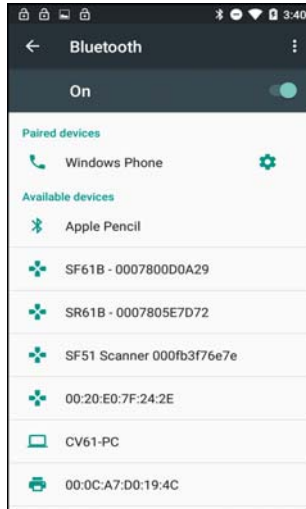

- 5 To disconnect a paired device, tap the name of the paired device and then tap **OK** when the Disconnect? screen appears.

Configure Bluetooth Settings

You configure Bluetooth settings in the Settings app.

- 1 Start the Settings app and tap **Bluetooth**.
- 2 Tap the Menu icon  and select a setting from the menu:
 - Tap **Rename phone** to change the device name. Type the new name and then tap **Rename**.
 - Tap **Show received files** to view statistics on the received files.

Rename or Disconnect a Paired Device

You can rename or disconnect a paired Bluetooth device from the Settings app.

- 1 Open the Settings app and tap **Bluetooth**.
- 2 Tap the Settings icon next to the paired device.

- 3 To rename the device, type the new name, and then tap **OK**.
To disconnect the device, tap **Unpair**.

View a List of Received Files

You can view a list of files received through the computer's Bluetooth connections with other devices.

- 1 Start the Settings app.
- 2 Tap Bluetooth and then tap the Menu icon .
- 3 Tap **Show received files**. A list of files received through the Bluetooth connection appears.

About Serial and USB Communications

You can use these accessories to transmit data to and receive data from another device through serial or USB communications:

- AV10 vehicle dock
- AA21 RS-232 adapter
- AD27 single dock
- Desktop USB adapter
- USB snap-on adapter
- RS-232 DEX adapter

For information on these accessories, contact your local sales representative.

How to Share Your Mobile Data Connection

You can share the mobile data connection through USB tethering or Bluetooth tethering. You can also use the computer as a Wi-Fi hotspot to share the connection with other devices.

Share the Data Connection Through USB

After you connect the computer to another device through USB, you can share the data connection through USB tethering.

- 1 Connect the mobile computer to another device through a USB dock, cable, or other connection.
- 2 Start the Settings app.
- 3 In the Wireless & networks section, tap **More** and then tap **Tethering & portable hotspot**.
- 4 Tap **USB tethering**. The device is now sharing the computer data connection.

To stop sharing the connection, disconnect the USB cable, or disable USB tethering.

Share the Data Connection Through Bluetooth

If your device is Bluetooth-capable, you can configure the computer to share its mobile data connection with the device through Bluetooth.

- 1 Start the Settings app.
- 2 In the Wireless & networks section, tap **More** and then tap **Tethering & portable hotspot**.
- 3 Tap **Bluetooth tethering**. You should now be able to pair your device with the computer to share the data connection.

To stop sharing the data connection, clear the check box for **Bluetooth tethering**.

Share the Data Connection as a Portable Hotspot

You can configure the computer to act as a portable Wi-Fi hotspot for up to eight other devices.

- 1 Start the Settings app.
- 2 In the Wireless & networks section, tap **More** and then tap **Tethering & portable hotspot**.

- 3** To share the data connection as a Wi-Fi hotspot, tap **Portable Wi-Fi hotspot**. The computer begins to broadcast its network name (SSID) so you can connect to it with up to eight other devices.

To restrict access to the computer when you are using it as a Wi-Fi hotspot, tap **Set up Wi-Fi hotspot** to select the security protocol and set up a password. When other devices try to connect to the hotspot, users are prompted to enter the password before the devices are allowed to connect. Or, to remove secure access, select **Open** from the Security list.

- 4** Tap **Save**.

7

Manage and Maintain the Computer

Use this chapter to understand how to upgrade software, reset the computer, and maintain the computer.

How to Transfer Files

To transfer files you need to physically connect the mobile computer to your desktop PC through a USB connection. When the computer is connected through USB, you can browse to it and drag-and-drop to move files back and forth to a Windows PC. If you are transferring files to and from a Mac, use the Android File Transfer application (available from www.android.com/filetransfer).



Note: File transfer through a USB connection is disabled by default. You need to configure the USB connection for transferring files or photos.

Configure the USB Connection for Transferring Files

By default, transferring files from the computer to a PC through a USB connection is disabled. Before you can transfer files, you need to change the connection settings.

- 1 In the main screen, swipe down to view the Notifications.

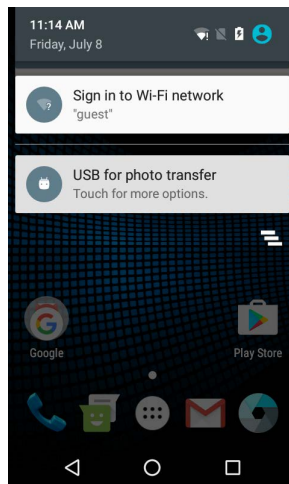

- 2 Tap **USB for charging**. This menu appears:

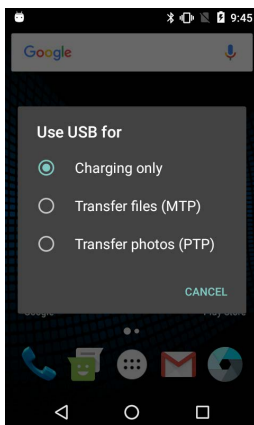

- 3 Tap **Transfer files (MTP)**. Or, if you will be transferring mainly photos, tap **Transfer photos (PTP)**. The USB settings are changed.

To verify the change, swipe down to view the Notifications.

Connect to a PC through USB

After you configure the USB connection for file transfer, use a USB cable and dock to connect the computer to a Windows PC to transfer files in both directions. If you are using USB tethering, you must turn tethering off before you can transfer files through USB.

- 1 Place the computer in a USB dock.
- 2 Connect the dock to your Windows PC. The mobile computer is mounted as a drive, and you can copy files in either direction as needed.
- 3 When you are done transferring files, disconnect the CN51.

How to Develop and Install Applications

You need the Android SDK and the Honeywell Mobility SDK for Android to develop applications for the CN51 running Android.

To download and install the Android SDK, visit <http://developer.android.com/sdk/index.html>.

Use the Honeywell Mobility SDK for Android to develop applications for the computer. The SDK includes libraries of Java components grouped by functionality:

- **Data Collection:** Provides functionality for using the imager in your application.
- **Printing:** Provides functionality for printing to selected Honeywell and Intermec mobile printers from your application.

Contact Honeywell Technical Support to obtain the Mobility SDK.

After you develop applications, you can install the apps using:

- ScanNGo bar codes.
- management applications.
- web installs.
- ADB push to the device.



Note: To install applications by scanning a bar code, you must enable this feature. In the Settings menu, select **Security**, and in the Device Administration section, select the **Unknown sources** check box.

For more information on developing and installing applications, see developer.android.com.

Download and Install the SDK Components

You use the Android SDK Manager to download and install the Honeywell Mobility SDK for Android components on your development PC. You must install the Android SDK to use the SDK Manager. For more information, visit developer.android.com.

Contact Honeywell Technical Support to obtain the Honeywell Mobility SDK for Android. Before you begin this procedure, install the SDK on your development PC.

- 1 Start Android SDK Manager.
- 2 Click **Tools > Manage Add-on Sites** and then click the **User-Defined Sites** tab.
- 3 Click **New**.
- 4 Enter this text:

```
https://sdk.honeywellaidc.com/sdk/addon.xml
```



- 5 Click **OK** and then click **Close**. The Intermec CN51 SDK add-on is added to the list of items for Android 4.2.2 (API17).
- 6 In the Android 4.2.2 section, select the packages you want to install, including **Intermec CN51 (API17)**.

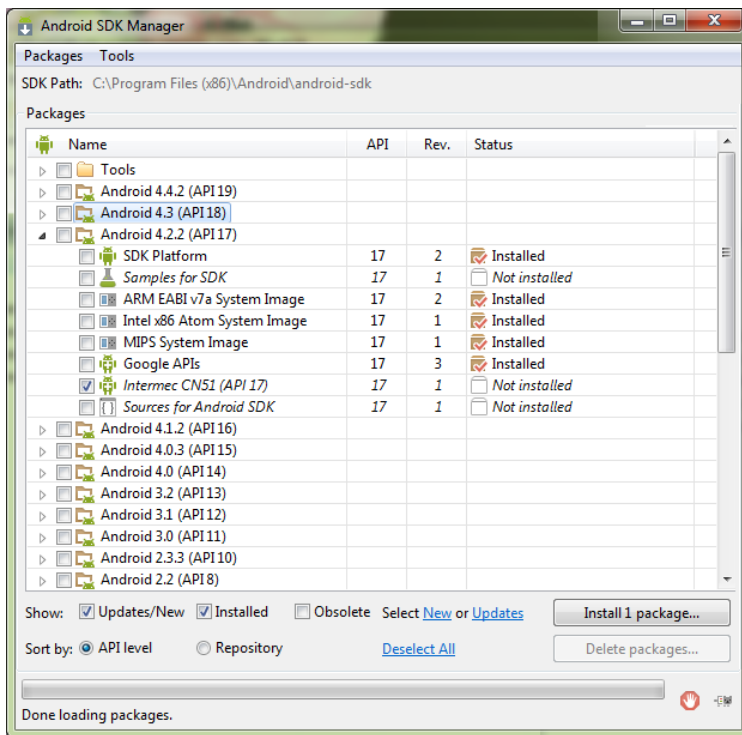

Note: You must install this package when developing for Android 6.0 (API 23). This process registers the Intermec USB vendor ID for ADB.

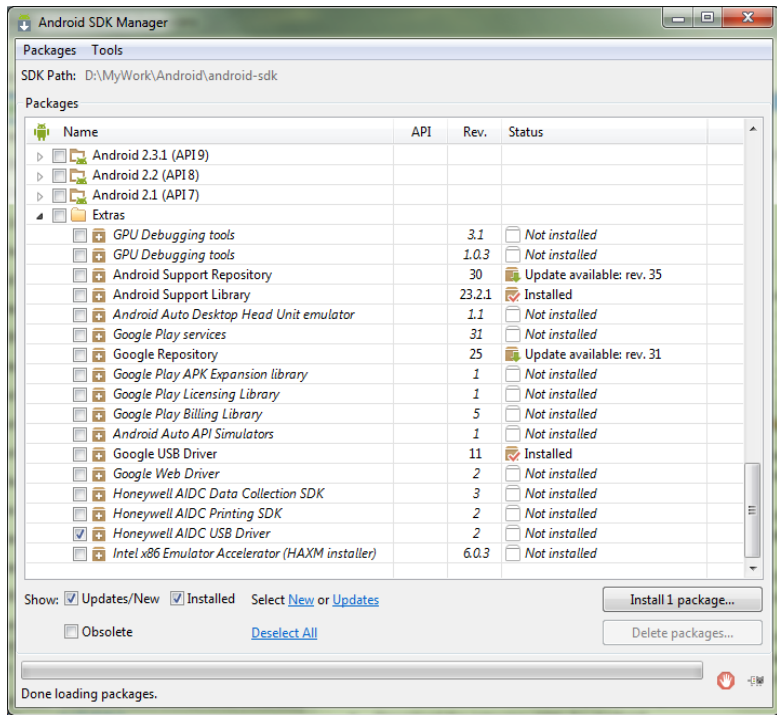

7 In the Extras section, select **Honeywell AIDC USB Driver**.



To use the Honeywell Mobility SDK for Android, select **Honeywell AIDC Data Collection SDK** and **Honeywell AIDC Printing SDK**. The packages will be installed under the “extras\honeywell” subfolder of the Android SDK installation folder. Each package may contain multiple SDKs for different Honeywell mobile computers. See the release notes to select the proper SDK for the CN51.

- 8 Click **Install x packages**, where *x* is the number of packages you selected in the previous step.
- 9 In the **Choose Packages to Install** dialog box, click **Accept License** and then click **Install**. The packages are downloaded to your development PC.

10 In the Android SDK folder on your development PC, browse to `extras\honeywell\usb_driver` and double-click **CN51_Windows_Drivers_1.xx.xx.xxxx.exe**, where `1.xx.xx.xxxx` is the latest version number of the software. The Honeywell USB driver is installed on your development PC.

11 From the command line, browse to the tools directory in the Android SDK directory and run this command:

```
android update adb
```

This command updates the Android Debug Bridge with the correct vendor ID.

How to Set Up the Mobile Computer for App Development

There are a few tasks you need to accomplish to set up the mobile computer for debugging and development work:

- Declare your app as debuggable in your Android Manifest.
- In the Settings app, you need to enable developer options and USB debugging on the computer.
- Set up your development PC to detect your device.

If you plan to use the Android Debug Bridge utility, you need a driver provided by Honeywell. The driver is included with the Honeywell Mobility SDK for Android.

For more information on setting up your computer for app development, go to:

<http://developer.android.com/tools/device.html>.

How to Update the System Software

You can use these methods to update the system software on the computer:

- You can update individual computers, or multiple computers at the same time, using a device management system. For help, see the documentation for your device management system.
- You can update individual computers by copying the software update file to the internal storage (or an installed microSD card) on each computer. Then you can manually start the system update from the Settings app.

Update Computers Using a Device Management System

You can update multiple computers at the same time using a device management system. Several mobile device management systems support the CN51 running Android, including SOTI MobiControl, Honeywell Skynax, and other third-party solutions. Contact these suppliers for information about obtaining their agent or client software for use with the CN51.

Upgrade the System Software

Upgrades for Power Tools and other system software on the computer are provided as .zip files and are available from Honeywell Technical Support.

- 1** Copy the upgrade .zip file into one of these folders on the computer:
 - Internal storage\honeywell\autoinstall
 - IPSM card\honeywell\autoinstall
 - \honeywell\autoinstall (on a microSD card if installed)
- 2** Tap **All Apps > Autoinstall Settings**.
- 3** Verify that Autoinstall is enabled.
- 4** Select **Packages Update** from the screen. The computer automatically initiates a reboot and installs the software upgrade.

Reset the Computer

If the computer or an application seems to be locked up, you can try resetting the computer to restore the operating system. You may lose data in open apps when you reset the computer. All your settings are saved during a reset.

- 1 Press and hold the **Power** button. This menu appears:

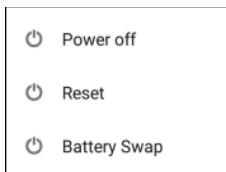

- 2 Tap **Reset**. The computer restarts.

Perform a Factory Data Reset



Caution: Performing a factory data reset completely erases all data, files, and downloaded apps from the computer memory. Back up your data and files before proceeding.

You can perform a factory data reset, which restores all default settings on the computer and erases all data, files, and downloaded apps.

- 1 Start the Settings app and tap **Backup & reset > Factory data reset**.
- 2 Tap **Reset phone**. A confirming message appears, reminding you that you cannot reverse this action.
- 3 Tap **Erase everything**. The computer restarts and all user data, files, and downloaded apps are erased.

Clean the Computer

To keep the computer in good working order, you may need to clean the scanner window, color camera window, and the touch screen. Clean the windows and the touch screen as often as needed for the environment in which you are using the computer. To clean the computer, use one of these recommended cleaning agents:

- Acetic acid, 10% in water
- Ethyl alcohol, 10% in water
- Mild soap solutions
- 5% to no more than 10% bleach or sodium hypochlorite with water



Caution: There are no user-serviceable parts inside the computer. Opening the computer will void the warranty and may cause damage to the internal components.



Note: Honeywell recommends that you leave the battery installed when you clean the computer as described. Leaving the battery installed helps prevent fluids from entering the computer through the SIM card and microSD card connectors.

- 1** Press the **Power** button to suspend the computer.
- 2** Dip a clean cloth towel in the cleaning agent and wring out the excess.
- 3** Wipe off the scanner window, camera lens, and flash area. Do not allow any abrasive material to touch these surfaces.
- 4** Wipe dry.
- 5** Let the computer completely air dry before using again.

A

Specifications

Physical and Environmental Specifications

This section lists the physical and environmental specifications for the computer.

Physical Dimensions

Length:	16.5 cm (6.5 in)
Width (at widest part):	7.6 cm (3.0 in)
Depth (at grip):	3.2 cm (1.25 in)
Weight (with battery):	350 g (12.3 oz)

Tumble and Drop Specifications

Tumble Specification:	1,000 (0.5 m) tumbles per IEC 60068-2-32 specification.
Drop Specification:	Multiple 1.5 m (5 ft) drops to concrete at ambient temperature, multiple 1.2 m (4 ft) drops to concrete across the operating temperature range per MIL-STD 810G.

Power and Electrical Specifications

Operating battery:	Rechargeable lithium-ion battery
Backup battery:	Supercap supplies 1.5 minutes of bridge time while replacing the main battery.
Electrical rating:	 4,65 V, 1.5 A

Temperature and Humidity Specifications

Operating temperature:	-10 °C to 50 °C (14 °F to 122 °F)
Storage temperature:	-20 °C to 60 °C (-4 °F to 140 °F). For maximum battery life store at 23 °C (73 °F) at 50% charge.
Charging temperature:	0 °C to 45 °C (32 °F to 113 °F). 20 °C to 25 °C (68 °F to 77 °F) will provide extended battery life.
Relative humidity (operating):	5% to 95% non-condensing

Temperature and Humidity Specifications (Continued)

Environmental rating: IP54, Category 1

Screen Specifications

- 480 x 800 pixels
- 10.16 cm (4.0 in) transmissive WVGA display
- LCD capable of both portrait and landscape operation
- LED backlight
- Ambient light sensor

Keypad Options

- Alphanumeric keypad
- Numeric keypad

Bar Code Symbologies

- 2D Postal Settings
- Aztec*
- China Post
- Codabar
- Codablock A
- Codablock F
- Code 11
- Code 39
- Code 93
- Code 128/GS1-128
- DataMatrix
- EAN/UPC
- Composite
- GS1 DataBar Expanded
- GS1 DataBar Limited
- GS1 DataBar Omni-Directional
- HanXin
- IATA 2 of 5
- Interleaved 2 of 5
- Matrix 2 of 5
- Maxicode
- Micro PDF417
- MSI
- OCR
- PDF417*
- QR Code*
- Standard 2 of 5
- Telepen
- TLC 39
- Trioptic

EA31 Extended Reading Range

These typical reading distances are measured in an office environment (250 lux) for the EA31 standard model with Extended Reading Range activated. Extended Reading Range is enabled by default.

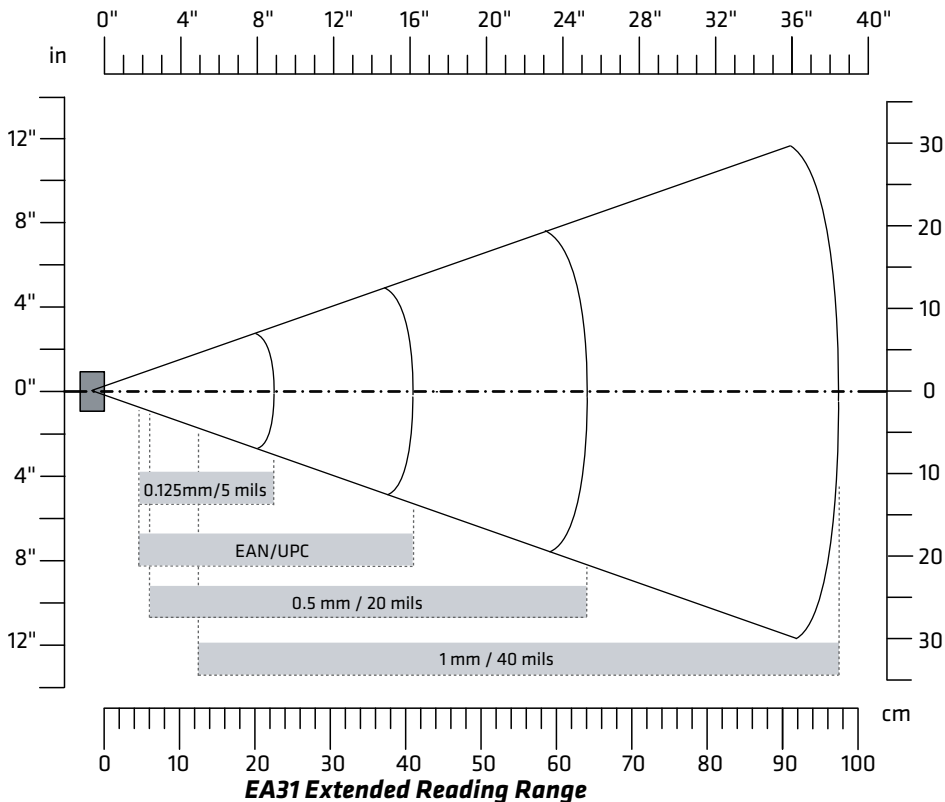

EA31 Extended Reading Range Activated

Symbology	Density	Minimum Distance	Maximum Distance
Code 39	0.125 mm/5 mils	4.50 cm/1.77 in	22.50 cm/8.86 in
	0.50 mm/20 mils	6.00 cm/2.36 in	64.00 cm/25.20 in
	1 mm/40 mils	12.50 cm/4.92 in	97.50 cm/38.39 in
EAN/UPC 100%	0.33 mm/13 mils	4.50 cm/1.77 in	41 cm/16.14 in

EA31 Minimum Reading Distances

Minimum reading distances are measured in the dark (0 lux).

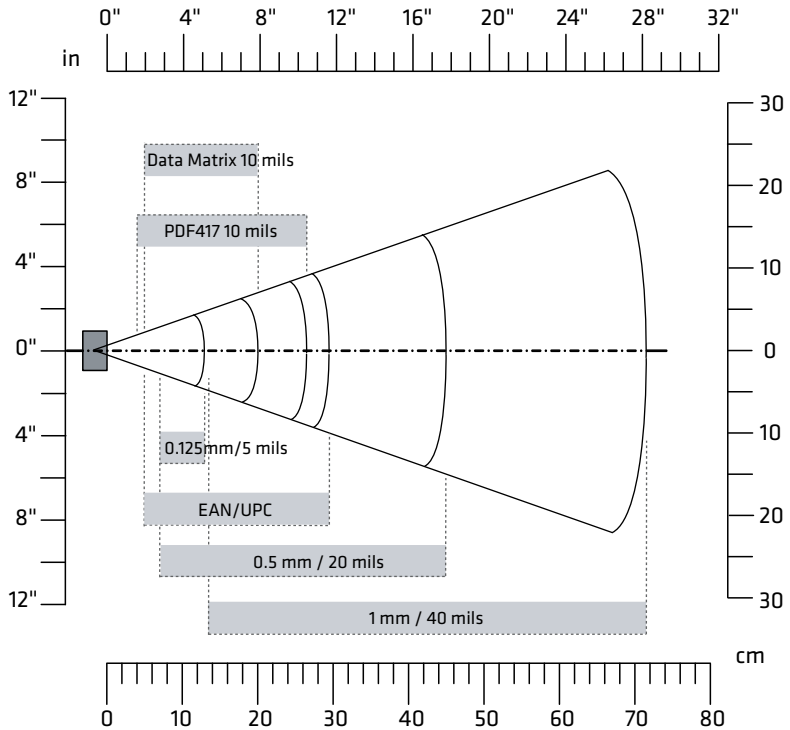

EA31 Minimum Reading Distances

EA31 Minimum Reading Distances

Symbology	Density	Minimum Distance	Maximum Distance
Code 39	0.10 mm/4 mils	8 cm/3.15 in	10 cm/3.94 in
	0.13 mm/5 mils	7 cm/2.76 in	13 cm/5.12 in
	0.20 mm/8 mils	4 cm/1.57 in	20 cm/7.87 in
	0.25 mm/10 mils	3.8 cm/1.5 in	24.5 cm/9.65 in
	0.50 mm/20 mils	7 cm/2.76 in	45 cm/17.72 in
	1 mm/40 mils	13.5 cm/5.31 in	71.5 cm/28.15 in
EAN/UPC 100%	0.33 mm/13 mils	5 cm/1.97 in	29.5 cm/11.61 in

EA31 Minimum Reading Distances (Continued)

Symbology	Density	Minimum Distance	Maximum Distance
DataMatrix	0.18 mm/7 mils	7 cm/2.76 in	14 cm/5.51 in
	0.25 mm/10 mils	5 cm/1.97 in	20 cm/7.87 in
	0.38 mm/15 mils	5.2 cm/2.05 in	29.5 cm/11.61 in
PDF417	0.17 mm/6.6 mils	5.8 cm/2.28 in	17.5 cm/6.89 in
	0.25 mm/10 mils	4 cm/1.57 in	26.5 cm/10.43 in
	0.38 mm/15 mils	4.9 cm/1.93 in	37 cm/14.57 in

EA31 Typical Reading Distances

Minimum reading distances are measured in the dark (0 lux).

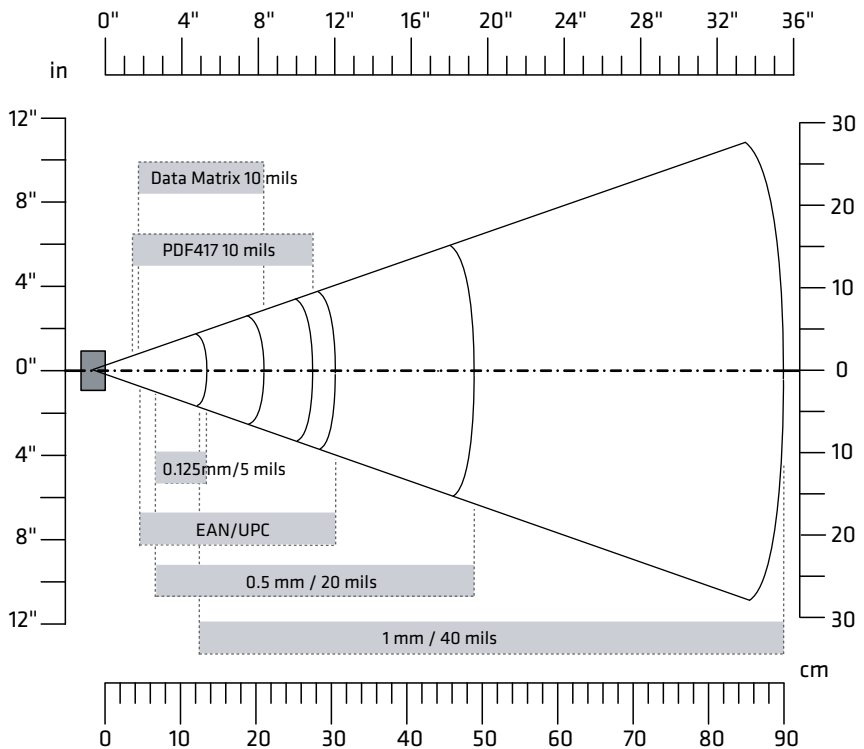

EA31 Typical Reading Distances

EA31 Typical Reading Distances

Symbology	Density	Minimum Distance	Maximum Distance
Code 39	0.10 mm/4 mils	7.5 cm/2.95 in	10.5 cm/4.13 in
	0.13 mm/5 mils	6.5 cm/2.56 in	13.5 cm/5.31 in
	0.20 mm/8 mils	4 cm/1.57 in	21 cm/8.27 in
	0.25 mm/10 mils	3.5 cm/1.38 in	25.5 cm/10 in
	0.50 mm/20 mils	6.5 cm/2.56 in	49 cm/19.29 in
	1 mm/40 mils	12.5 cm/4.92 in	90 cm/35.43 in
EAN/UPC 100%	0.33 mm/13 mils	4.5 cm/1.77 in	30.5 cm/12.01 in
DataMatrix	0.18 mm/7 mils	6.5 cm/2.56 in	15 cm/5.91 in
	0.25 mm/10 mils	4.5 cm/1.77 in	21 cm/8.27 in
	0.38 mm/15 mils	4.7 cm/1.85 in	31 cm/12.20 in
PDF417	0.17 mm/6.6 mils	5 cm/1.97 in	18.2 cm/7.17 in
	0.25 mm/10 mils	3.7 cm/1.46 in	27.5 cm/10.83 in
	0.38 mm/15 mils	4.5 cm/1.77 in	40 cm/15.75 in

EA30 Extended Reading Range

These typical reading distances are measured in an office environment (250 lux) for the EA30 standard model with Extended Reading Range activated. Extended Reading Range is enabled by default.

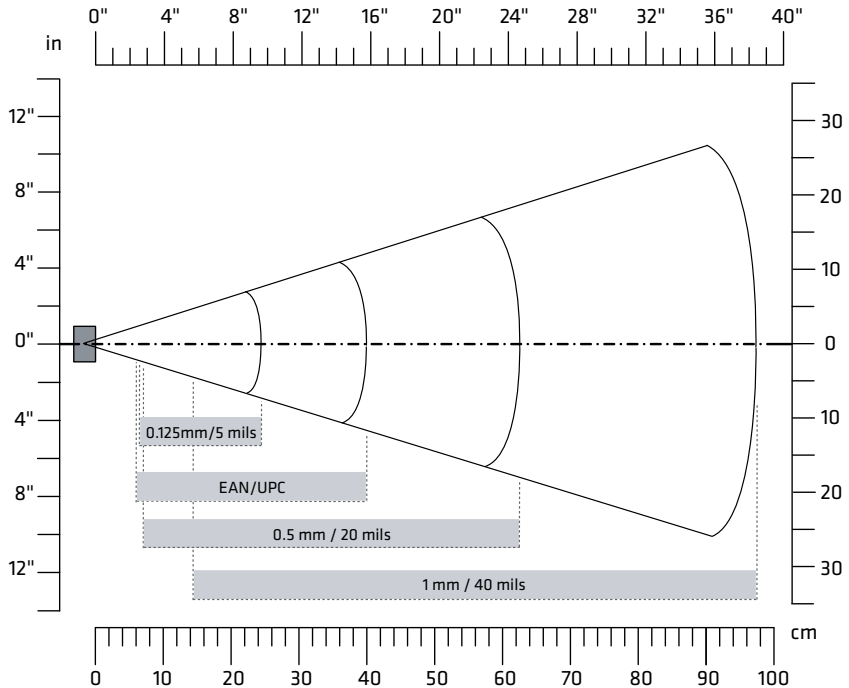

EA30 Extended Reading Range Activated

EA30 Extended Reading Range Activated

Symbology	Density	Minimum Distance	Maximum Distance
Code 39	0.125 mm/5 mils	64.50 cm/2.56 in	24.50 cm/9.65 in
	0.50 mm/20 mils	7.00 cm/2.76 in	62.50 cm/24.61 in
	1 mm/40 mils	14.50 cm/5.71 in	97.50 cm/38.39 in
EAN/UPC 100%	0.33 mm/13 mils	6 cm/2.36 in	40 cm/15.75 in

EA30 Minimum Reading Distances

Minimum reading distances are measured in the dark (0 lux).

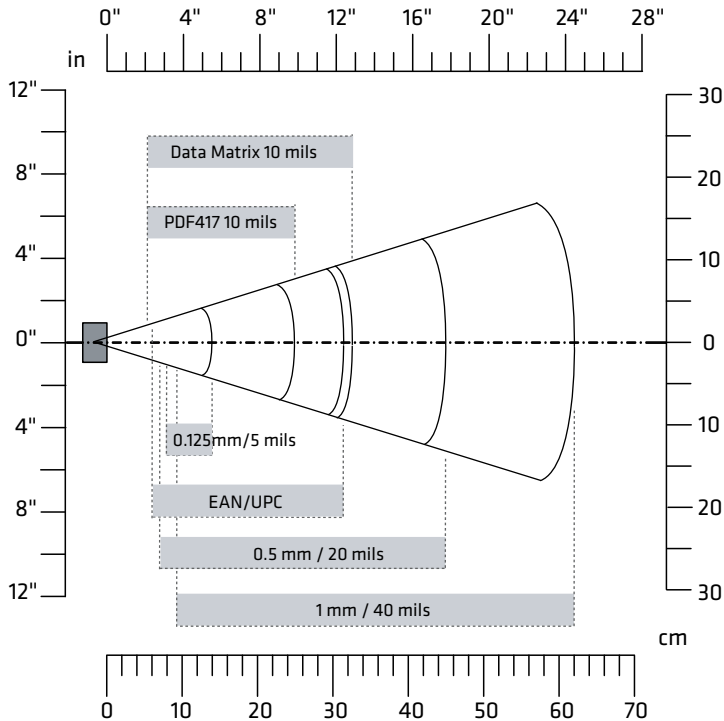

EA30 Minimum Reading Distances

EA30 Minimum Reading Distances

Symbology	Density	Minimum Distance	Maximum Distance
Code 39	0.10 mm/4 mils	9.5 cm/3.74 in	10.5 cm/4.13 in
	0.13 mm/5 mils	8 cm/3.15 in	14 cm/5.51 in
	0.50 mm/20 mils	7 cm/2.76 in	45 cm/17.72 in
	1 mm/40 mils	9.5 cm/3.74 in	62 cm/24.41 in
EAN/UPC 100%	0.33 mm/13 mils	6 cm/2.36 in	31.5 cm/12.4 in
DataMatrix	0.18 mm/7 mils	8 cm/3.15 in	15.5 cm/6.1 in
	0.25 mm/10 mils	6.5 cm/2.56 in	21.5 cm/8.46 in
	0.38 mm/15 mils	5.5 cm/2.17 in	31.5 cm/12.4 in

EA30 Minimum Reading Distances (Continued)

Symbology	Density	Minimum Distance	Maximum Distance
PDF417	0.25 mm/10 mils	5.5 cm/2.17 in	25 cm/9.84 in
	0.38 mm/15 mils	7 cm/2.76 in	34 cm/13.39 in

EA30 Typical Reading Distances

Minimum reading distances are measured in the dark (0 lux).

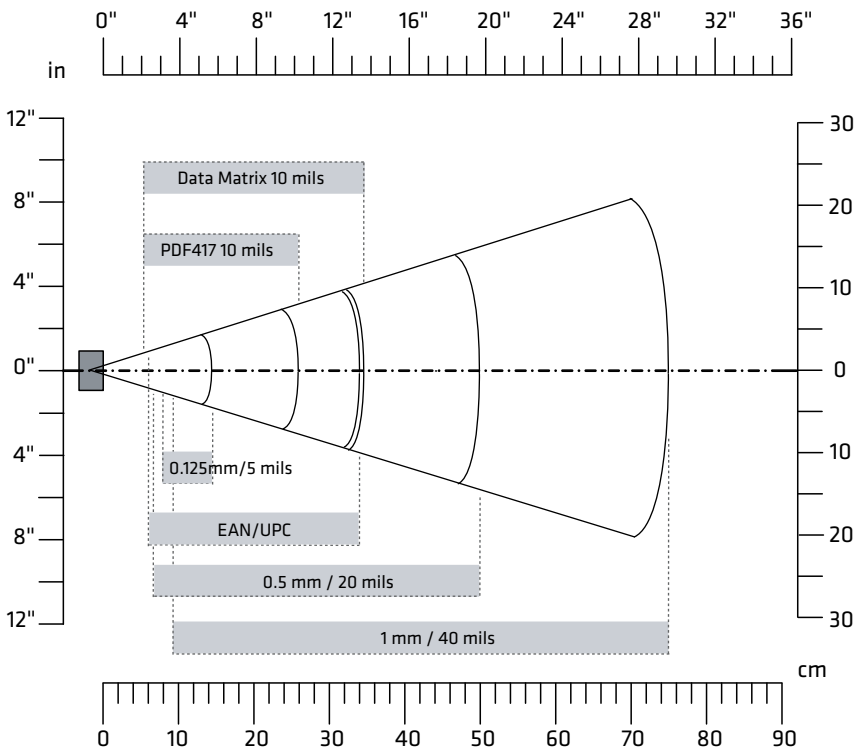

EA30 Typical Reading Distances

EA30 Typical Reading Distances

Symbology	Density	Minimum Distance	Maximum Distance
Code 39	0.10 mm/4 mils	9.5 cm/3.74 in	11.5 cm/4.53 in
	0.13 mm/5 mils	8 cm/3.15 in	14.5 cm/5.71 in
	0.50 mm/20 mils	6.5 cm/2.56 in	50 cm/19.69 in
	1 mm/40 mils	9.5 cm/3.74 in	75 cm/29.53 in
EAN/UPC 100%	0.33 mm/13 mils	6 cm/2.36 in	34 cm/13.39 in
DataMatrix	0.18 mm/7 mils	7.5 cm/2.95 in	16.5 cm/6.5 in
	0.25 mm/10 mils	6 cm/2.36 in	23 cm/9.06 in
	0.38 mm/15 mils	5.5 cm/2.17 in	34.5 cm/13.58 in
PDF417	0.25 mm/10 mils	5.5 cm/2.17 in	26 cm/10.24 in
	0.38 mm/15 mils	6.5 cm/2.56 in	37 cm/14.57 in

B

Default Settings

Wireless and Network Settings

This section lists all default wireless and network settings for the computer.

Wireless & Network Settings

Setting	Default
Wi-Fi	On
Bluetooth	Off
Ethernet	On
eth0	DHCP
Airplane mode	Disable
Portable Wi-Fi hotspot	Disable
Set up Wi-Fi hotspot	<ul style="list-style-type: none">• Network SSID: AndroidAP• Security: WPA2 PSK• Password: e61d78d7c877
Bluetooth tethering	Disable
Mobile network settings	<ul style="list-style-type: none">• Data enabled: Enable• Data Roaming: Disable• Use only 2G networks: Disable

Scanner Settings

This section lists all Default Profile settings for the internal scanner.

Data Processing Settings

Setting	Default
Wedge	On
Charset	ISO-8859-1
Prefix	None specified
Suffix	None specified
Wedge as keys	9, 10
Data Editing Plugin	None specified
Symbology Prefix	None

Data Processing Settings (Continued)

Setting	Default
Launch Browser	On
Scan to Intent	On
Launch EZ Config	On

Symbology Settings

Symbology	Default
2D Postal Settings	None
Aztec	On
China Post	Off
Codabar	On
Codablock A	Off
Codablock F	Off
Code 11	Off
Code 39	On
Code 93	Off
Code 128	On
DataMatrix	On
EAN-8	Off
EAN-13	On
Composite	Off
GS1 DataBar Expanded	Off
GS1 DataBar Limited	Off
GS1 DataBar Omni-Directional	Off
GS1-128	On
Han Xin	Off
IATA 2 of 5	Off
Interleaved 2 of 5	On
Korean Post	Off
Matrix 2 of 5	Off
Maxicode	Off
Micro PDF417	Off

Symbology Settings (Continued)

Symbology	Default
MSI	Off
OCR	Disabled
PDF417	Off
Planet	Off
QR Code	Off
Standard 2 of 5	Off
Telepen	Off
TLC 39	Off
Trioptic	Off
UPC-A	On
UPC-E	Off

Decode Settings

Setting	Default
Center Decode	Off

Imager Settings

Setting	Default
Override Recommended Values	Off

Trigger Settings

Setting	Default
Enable Scan Trigger	On
Scan delay	0
Decode timeout	20

Notification Settings

Setting	Default
Good Read Notification	On
Bad Read Notification	Off
Vibrate On Notification	Off

Device Settings

This section lists all default settings for computer-specific features such as sounds, battery management, or display settings.

Sound Settings

Setting	Default
Volumes	<ul style="list-style-type: none"> • Music, video, games, & other media: About 80% of full volume • Alarms: 100% of full volume • Ringtone & notifications: About 80% of full volume
Vibrate when ringing	Disable
Phone ringtone	Flutey phone
Default notification	Pixie dust
Dial pad touch tones	Enable
Screen lock sound	Enable
Charging sound	Enable
Touch sounds	Enable
Vibrate on touch	Enable
Cast: When device is locked	Show all notification content
App notifications: Notification access	Apps cannot read notifications

Display Settings

Setting	Default
Brightness	Adaptive brightness: Enabled
Wallpaper	Soundwave
Sleep	After 1 minute of inactivity
Daydream	On
Font size	Normal
When device is rotated	Rotate the contents of the screen

Personal Settings

This section lists default personal settings, including security features and language choices.

Personal Settings

Setting	Default
Location services	<ul style="list-style-type: none">• Google’s location service: Enable• Mode: Battery saving
Security	<ul style="list-style-type: none">• Screen lock: Swipe• Lock screen message: None• Encryption: Encrypt phone• Make passwords visible: Enable• Device administrators: Android Device Manager enabled• Unknown sources: Disable• Credential storage: Storage type - Software only; Trusted credentials - Display trusted CA certificates; Install certificates from SD card• Screen pinning: Off
Language & input	<ul style="list-style-type: none">• Language: English (United States)• Spell checker: Enable• Default keyboard: English (US) - Android keyboard (AOSP)• Pico TTS settings: English (United States), Normal speech rate• Mouse/trackpad pointer speed: Medium

System Settings

This section lists default system settings, including accessibility and developer options.

Date & Time Settings

Setting	Default
Automatic date & time	Enable
Automatic time zone	Enable
Use 24-hour format	Disable

Accessibility Settings

Setting	Default
TalkBack	Off
Switch Access	Off
System captions	Off
Magnification gestures	Off
Large text	Off
Power button ends call	Disable
Auto-rotate screen	Enable
Speak passwords	Disable
Accessibility shortcut	Off
Text-to-speech output	<ul style="list-style-type: none"> • Language: English (United States) • Speech rate: Normal
Color inversion	Off
Color correction	Off

Developer Options

Option	Default
Developer options	Off
Desktop backup password	None specified
Stay awake	Disable

Developer Options (Continued)

Option	Default
Enable Bluetooth HCI snoop...	Disable
OEM unlocking	Disable
Protect SD card	Disable
USB debugging	Disable
Enable view attribute inspection	Disable
Select debug app	None specified
Logger buffer sizes	256K per log buffer
Wireless display certification	Disable
Enable Wi-Fi Verbose Logging	Disable
Aggressive Wi-Fi to Cellular...	Disable
Always allow Wi-Fi Roam Scans	Disable
Use legacy DHCP client	Disable
Cellular data always active	Disable
Select USB Configuration	MTP (Media Transfer Protocol)
Show touches	Disable
Pointer location	Disable
Show surface updates	Disable
Show layout bounds	Disable
Force RTL layout direction	Disable
Window animation scale	1x
Transition animation scale	1x
Animator duration scale	1x
Simulate secondary displays	None
Force GPU rendering	Disable
Show GPU view updates	Disable
Show hardware layers updates	Disable
Debug GPU overdraw	Disable
Debug non-rectangular clip operations	Off
Force 4x MSAA	Disable
Disable HW overlays	Disable
Simulate color space	Disable

Developer Options (Continued)

Option	Default
Disable USB audio routing	Disable
Strict mode enabled	Disable
Show CPU usage	Disable
Profile GPU rendering	Off
Enable OpenGL traces	None
Don't keep activities	Disable
Background process limit	Standard limit
Show all ANRs	Disable



Note: All developer options are turned off by default. The options listed are enabled only when developer options are turned on. For more information, go to developer.android.com.

Additional Honeywell Settings

This section lists additional Honeywell default settings.

Battery LED Settings

Setting	Default
HSM Battery LED	Enabled
Android Default Battery LED	Disabled
No Battery LED	Disabled

Logger Settings

Setting	Default
LogDump	Off

Honeywell

www.honeywellaidc.com

Copyright © 2016

Honeywell International Inc.

All rights reserved.



CN51 Mobile Computer User Manual



P/N 935-078-003